

10. Mini Coax Connectors

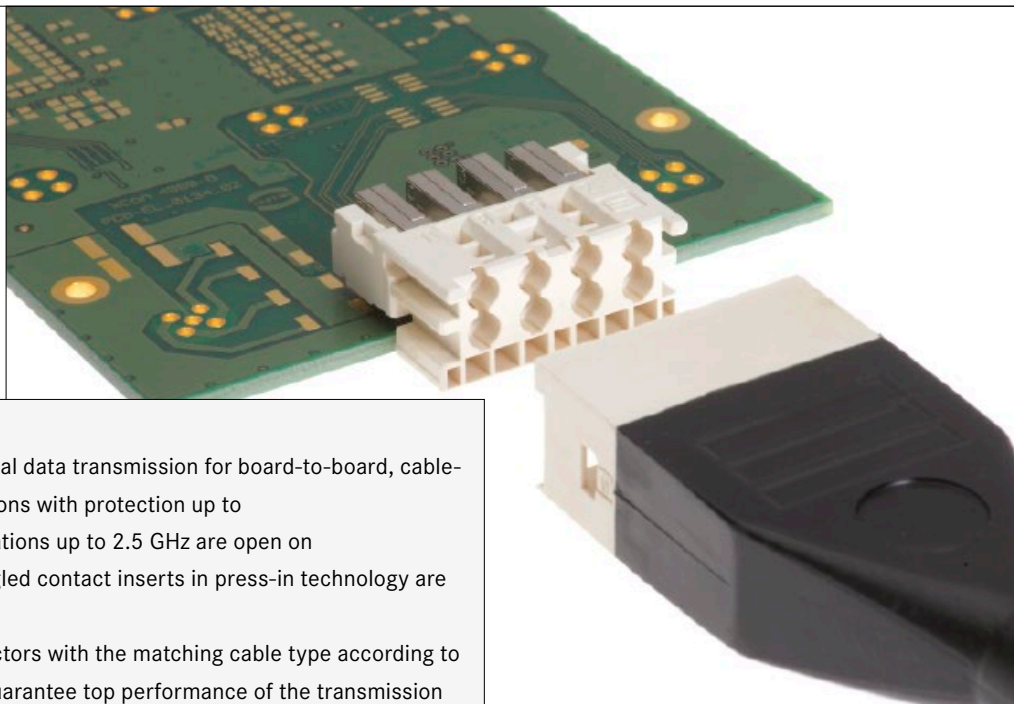

The Mini Coax allows multi-pole coaxial data transmission for board-to-board, cable-to-board and cable-to-cable applications with protection up to IP65 / IP67. At the same time, applications up to 2.5 GHz are open on the basis of 50 Ohm. Straight and angled contact inserts in press-in technology are available for device integration.

HARTING assembles Mini Coax connectors with the matching cable type according to customer specifications in order to guarantee top performance of the transmission lines. A special feature is the connector overmolding, which guarantees a top quality and robust connection between the cable and connector.

Application profile:

CONNECTION TYPE		ENVIRONMENT		APPLICATION						
Board to Board	Cable/Wire to Board	IP20	IP65 / IP67	Data	Signal	Power	high performance			
							Data transfer rate	Shielding	Number of contacts, contact density	Voltage, working current
Cable termination			PCB termination			Application standard				
<i>Han-Quick Lock®</i>	<i>IDC</i>	<i>Crimp</i>	<i>THT</i>	<i>SMC</i>	<i>SMT</i>					
<i>Screw</i>	<i>Cage clamp</i>	<i>Axial screw</i>	<i>Press-in</i>					Housing integration		
								<i>Separate housing</i>	<i>Integrated housing</i>	

10. Mini Coax Connectors



Contents

Page

Mini Coax connector system – introduction	10.02
Mini Coax connector system – general information	10.04
Technical characteristics	10.06
Straight Mini Coax Standard modules for backplane assembly	10.08
Angled Mini Coax Standard modules for daughtercard assembly	10.09
Angled Mini Coax single-row modules for daughtercard assembly	10.10
Mini Coax cable assemblies – general information	10.11
Assemblies with standard modules	10.12
Assemblies with single-row modules and with heavy duty hoods/housings	10.14
Accessories	10.15

Mini Coax

Mini Coax tooling see chapter 20

10. Mini Coax Connectors



MULTI-COAXIAL CONNECTOR SYSTEM MINI COAX

The HARTING multi line Mini Coax connector system for board-to-backplane RF interconnection includes connectors for press-in technology with 1 to 10 coaxial lines.

The Mini Coax connector range allows transmission of analogue signals in various applications like cellular base transceiver stations (BTS), repeaters and passenger entertainment systems at radio frequencies up to 2.5 GHz per line at 50 Ohm.

Moreover, these compact and rugged connectors provide a 6 Sigma mating reliability thanks to the closed-entry contact design. The compact size of Mini Coax modules (minimum pitch of RF lines is 4.4 mm), combined with excellent RF-performance,

makes this connector system especially suitable for high-end equipment.

The twin modules are available in metric sizes of 1.00, 1.25 and 1.50 SU (SU = System Unit = 25 mm) for both cable assemblies and PCBs with 2 to 10 coaxial lines, as well as a single row version with 1 to 3 coaxial lines.

HARTING offers customised cable assemblies including adaptor cables to the most popular discrete coaxial contacts such as SMA, SMB, BNC, N-Type, etc. A complete range of accessories and tools supports the wide product range.

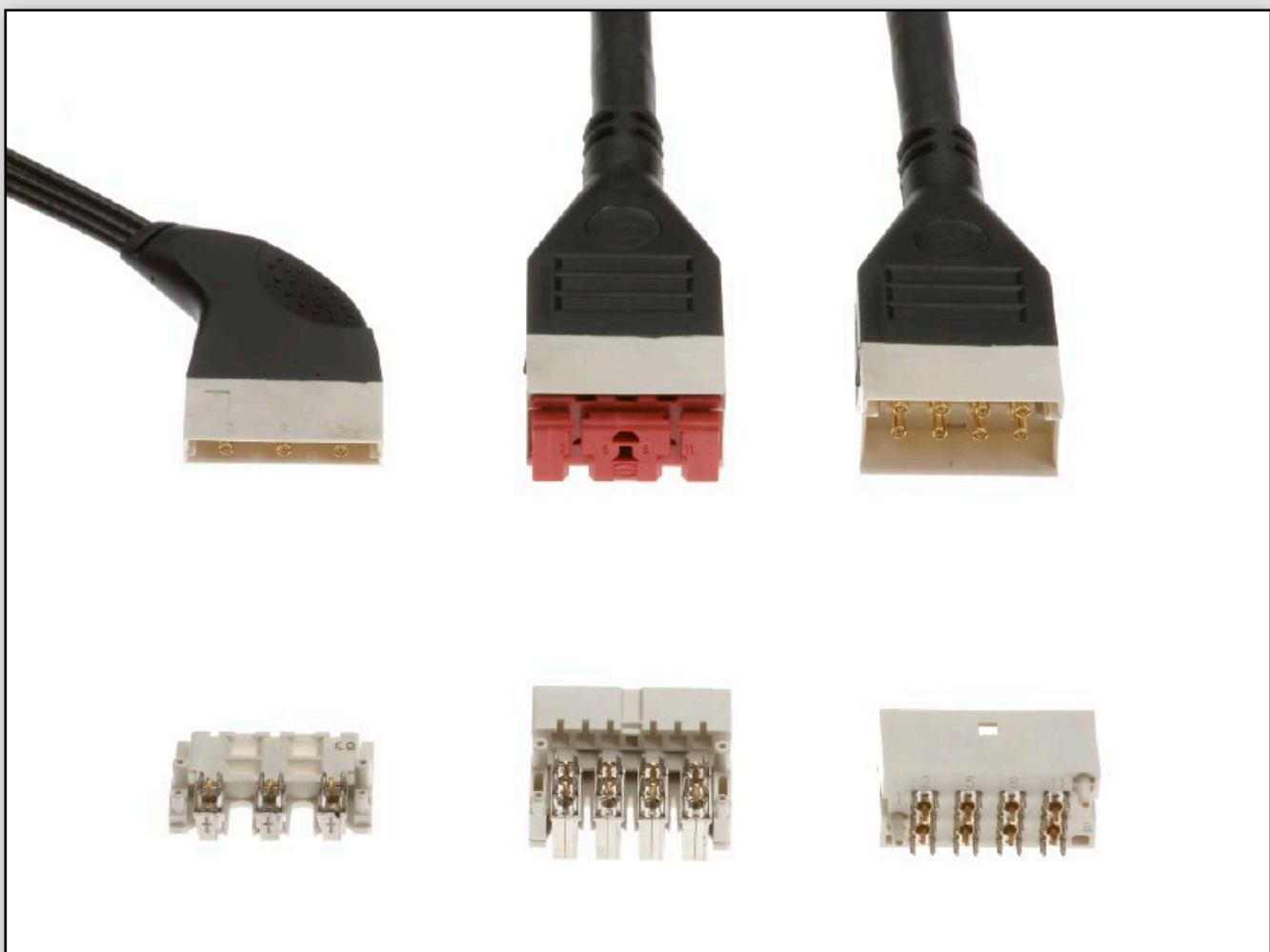

Specific features of the product range



CAN BE USED IN MIXED CONFIGURATION

As board-to-board connectors Mini Coax and *har-bus*® HM connectors can be used on board in any mixed configuration.

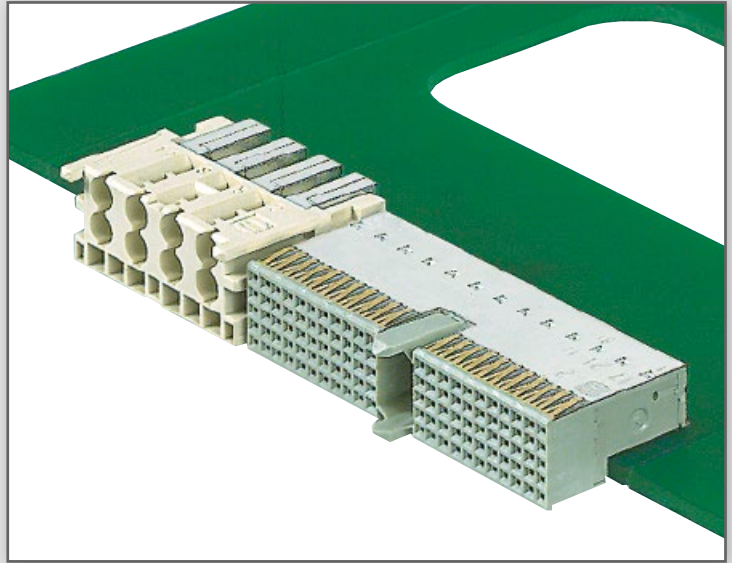

HIGH DATA TRANSMISSION RATE

The press-in termination offers an easy processing with very high frequency rates up to 2.5 GHz (even 4.5 GHz with the single row connector).

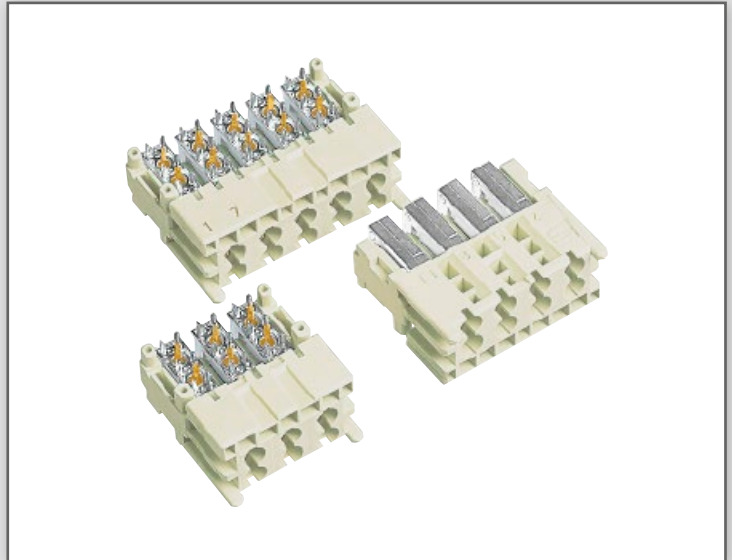

IP65 ENVIRONMENT

The combination of a Mini Coax connector with a Han® housing results in a proper IP65 Industrial Mini Coax connector.



Mini
Coax

Mini Coax connector system

General information



The Mini Coax connector is a multi line RF connector for blind mating of board-to-board, board-to-cable or cable-to-cable applications. The Mini Coax connector is mainly used in both RF (Radio Frequency) and IF (Intermediate Frequency) signal transmission and is specified for a frequency range from DC to 2.5 GHz and beyond. Thanks to its compact size (a 10 coaxial contacts' connector is as small as a PC's enter key) and excellent crosstalk features, this connector system is ideal for high end equipment within cellular telecom infrastructure.

The isolated coaxial lines are implemented in a plastic housing that defines the module size in a metric scale from 1.00, 1.25 and 1.50 SU

(SU = System Unit = 25 mm). The Mini Coax connectors are available as straight sockets and right angled plugs. Both types are executed in press-in technology for the PCB (Printed Circuit Board) termination. The straight modules are delivered with an inserted plastic cap that protects the coaxial contacts against dust and dirt, as well as being used as an upper press-in tool. In this way, an easy and safe flat rock process is guaranteed.

The contacts of the Mini Coax single-row connector are single line, as opposed to the standard connector. This delivers enhanced performance, especially in terms of isolation, and is also suitable for slim cabinet applications.

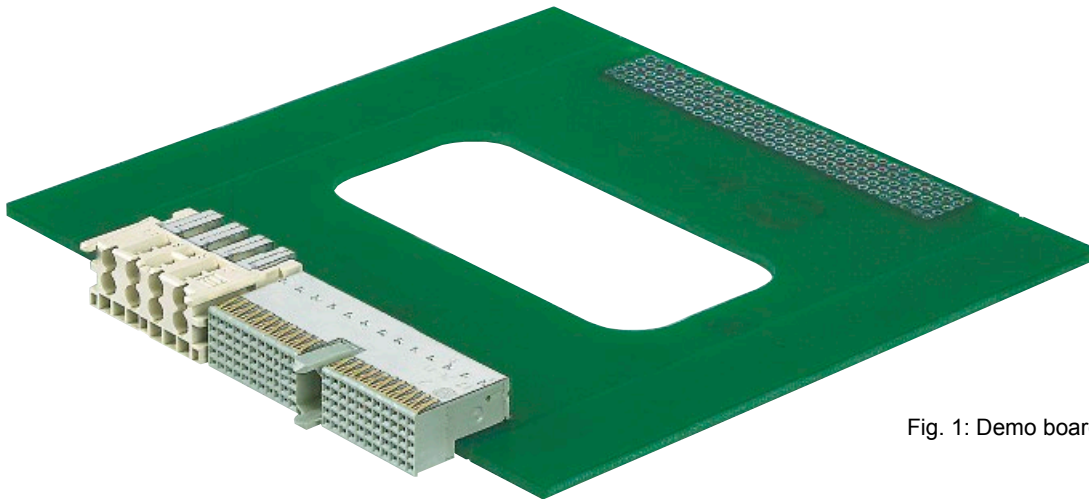

Fig. 1: Demo board

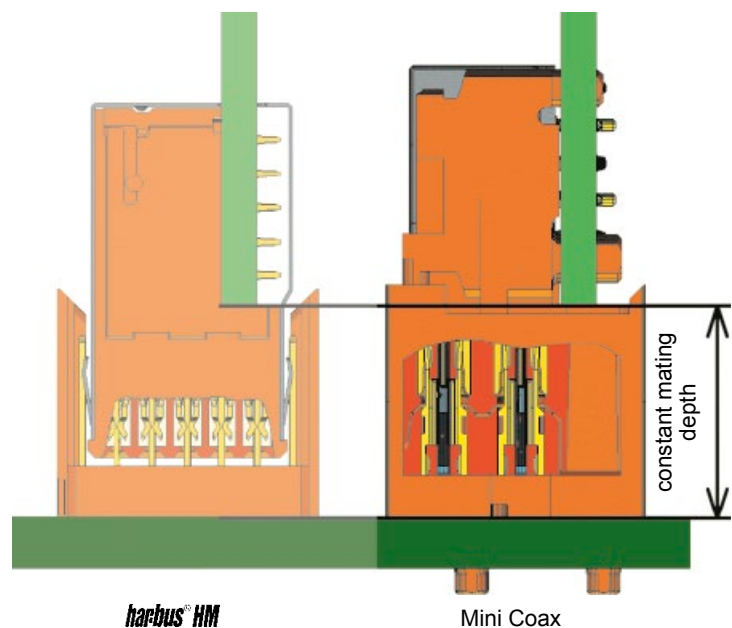

Fig. 2: Cross section of both connector types

Mini Coax connector system

General information

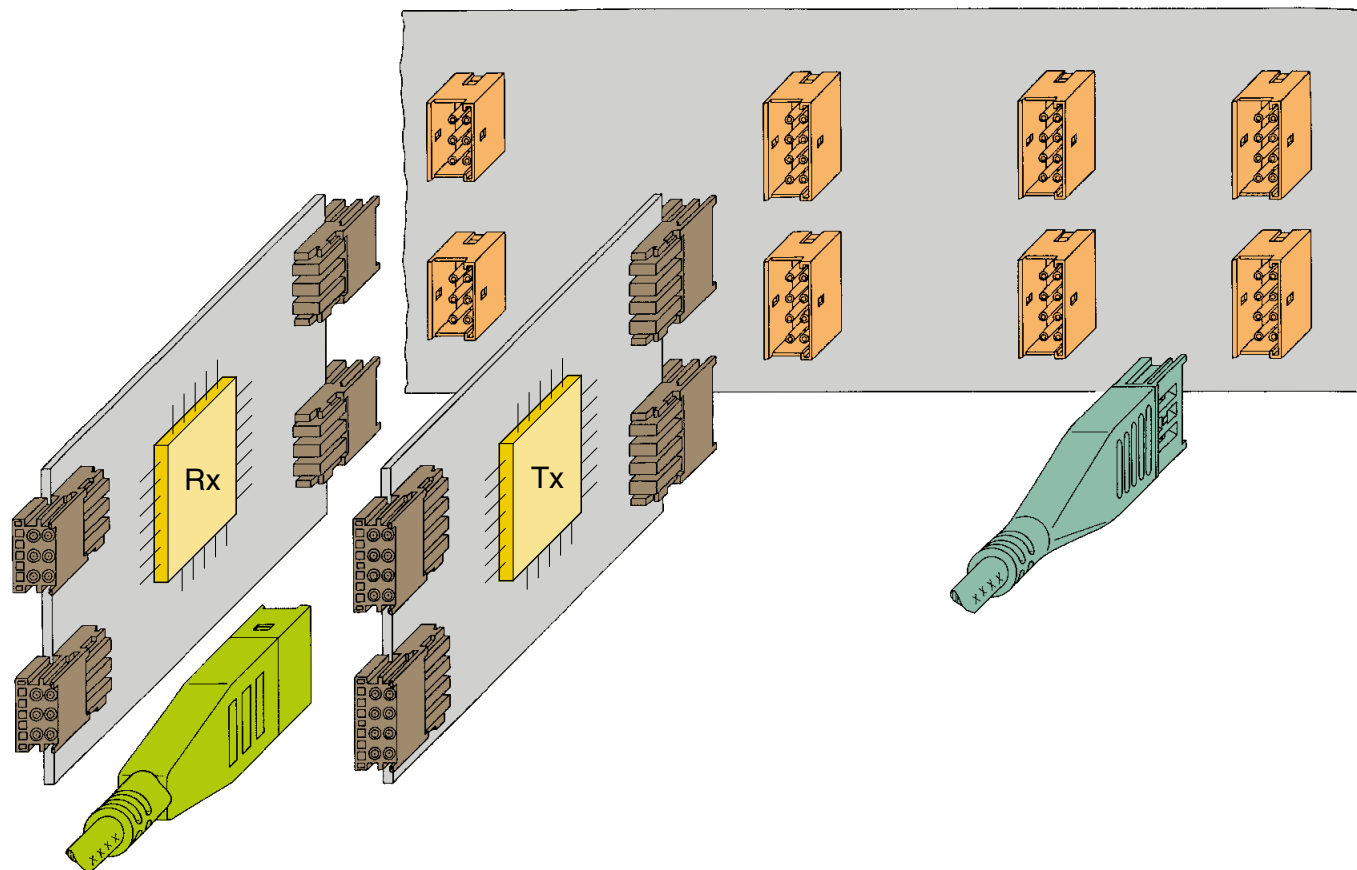

Fig. 3: Typical pcb configurations

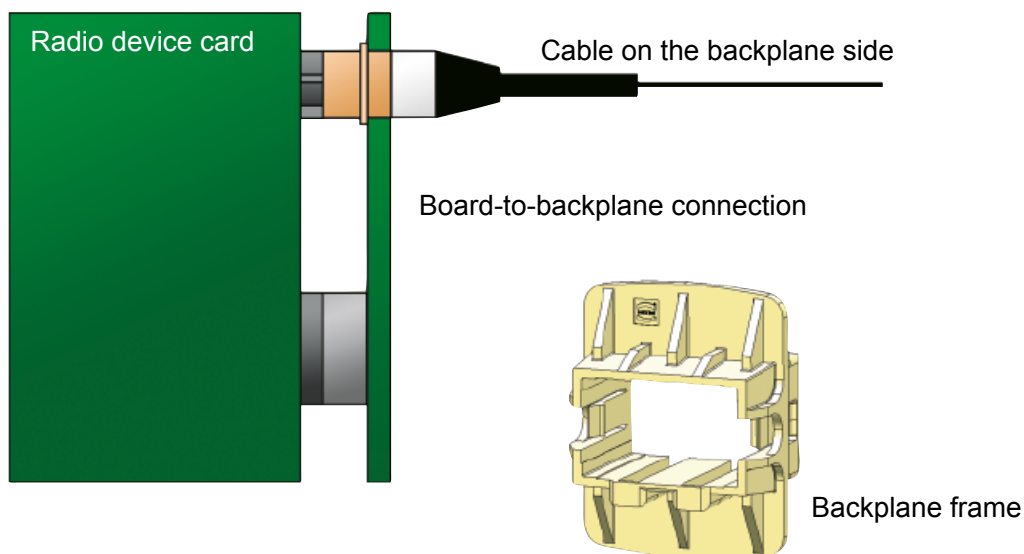

Fig. 4: Mini Coax backplane feed through

Mini Coax

Mini Coax

Technical characteristics



Number of contacts : 1, 2, 4, 6, 8 or 10 coaxial contacts
 Grid pattern : 4.40 x 6.25 mm (within a twin x between twins);
 8.80 mm for Mini Coax single-row connectors

Dielectric withstanding Voltage $U_{r.m.s.}$: ≤ 1000 V (for 60 s)
 DC-contact resistance
 Centre contact : ≤ 12 m Ω
 Ground contact : ≤ 6 m Ω
 Insulation resistance : ≥ 5000 M Ω

Power : ≤ 40 W (at 2.5 GHz)
 Frequency range : DC ... 2.5 GHz
 Nominal impedance : 50 Ω
 Return loss : < -20 dB
 VSWR : < 1.22
 Insertion loss : < 0.25 dB

Near end crosstalk (NEXT) :

Pin distance	Board-to-Board	Board-to-Cable	Cable-to-Cable
$\Delta x = 4.40$ mm	50 dB	60 dB	90 dB
$\Delta x = 6.25$ mm	60 dB	70 dB	90 dB
$\Delta x = 7.64$ mm	75 dB	80 dB	90 dB
$\Delta x = 8.80$ mm	–	75 dB	–
$\Delta x = 12.50$ mm	90 dB	90 dB	90 dB

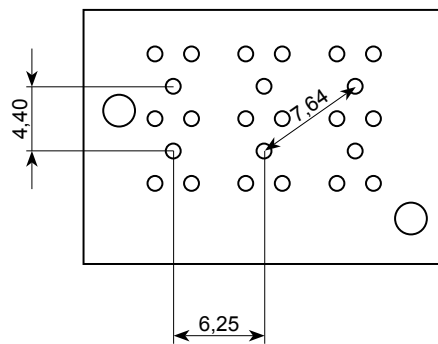

Fig. 5: Grid pattern
Mini Coax Standard

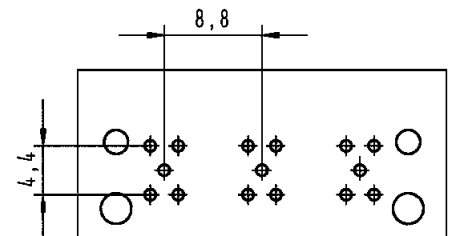

Fig. 6: Grid pattern
Mini Coax single-row

Temperature range : -55 °C ... $+125$ °C

Moulding material : Liquid Cristal Polymer (LCP), UL 94-V0
 Contact surface
 Contact zone : Au
 Termination area
 Centre pin : Au
 Ground pin : Ni

Mini Coax

Mini Coax

Technical characteristics



Mating cycles : max. 500

Recommended configuration of plated through holes :

<i>Tin plated PCB (HAL) acc. EN 60352-5</i>	Hole-Ø	1.15 ^{±0.025} mm
	Cu	min. 25 µm
	Sn	max. 15 µm
	Plated hole-Ø	0.94-1.09 mm
<i>Chemical tin plated PCB</i>	Hole-Ø	1.15 ^{±0.025} mm
	Cu	min. 25 µm
	Sn	min. 0.8 µm
	Plated hole-Ø	1.00-1.10 mm
<i>Au / Ni plated PCB</i>	Hole-Ø	1.15 ^{±0.025} mm
	Cu	min. 25 µm
	Ni	3-7 µm
	Au	0.05-0.12 µm
	Plated hole-Ø	1.00-1.10 mm
<i>Silver plated PCB</i>	Hole-Ø	1.15 ^{±0.025} mm
	Cu	min. 25 µm
	Ag	0.1-0.3 µm
	Plated hole-Ø	1.00-1.10 mm
<i>OSP copper plated PCB</i>	Hole-Ø	1.15 ^{±0.025} mm
	Cu	min. 25 µm
	Plated hole-Ø	1.00-1.10 mm

PCB board thickness: ≥ 1.6 mm

Mating force : ≤ 10 N/contact

Withdrawal force : > 1 N/contact

Mating distance : 12.5 ... 15 mm

Wiping length : 2.5 mm

Acceptable radial mating offset : max. ± 1.5 mm

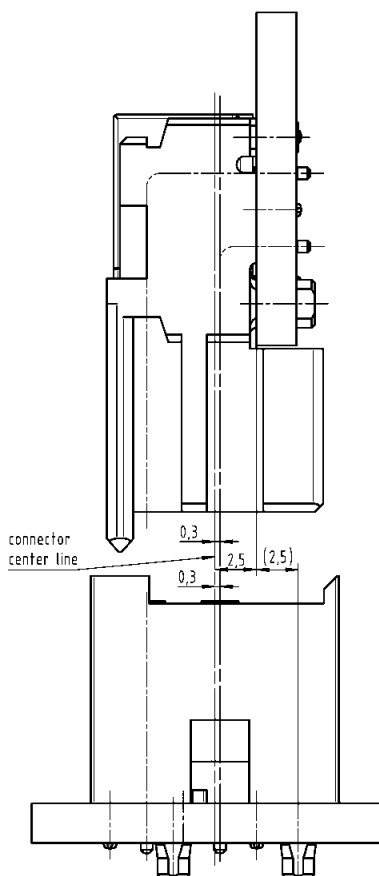

Mini Coax

Standard

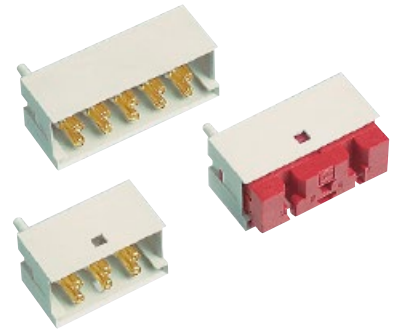

Straight modules

Identification	Number of contacts	SU	loaded positions	Part number
Mini Coax modules, press-in termination	10	1.50	2, 5, 8, 11, 14	07 11 100 0026
	8	1.25	2, 5, 8, 11	07 11 100 0024
	6	1	2, 5, 8	07 11 100 0023
	4	1	2, 8	07 11 900 0024
	2	1	2	07 11 900 0023

Dimensions

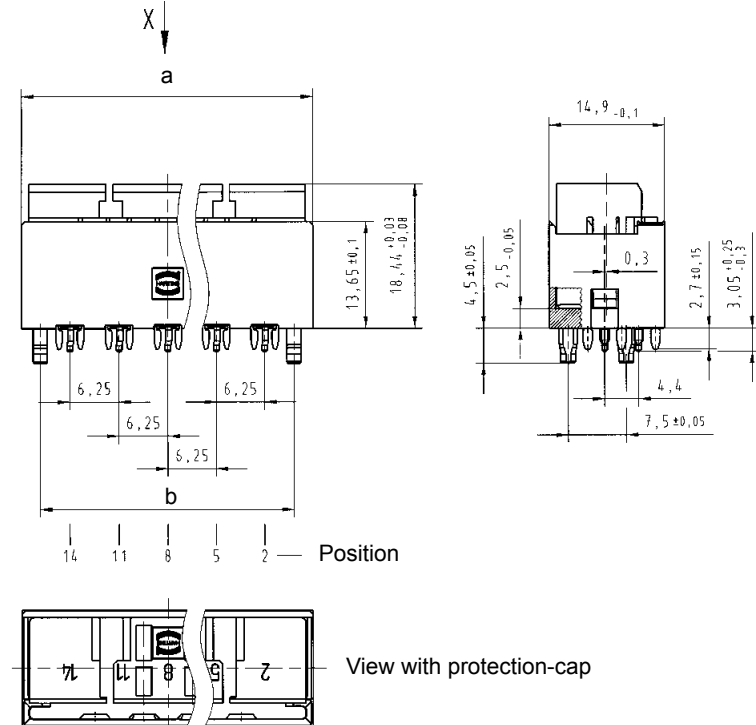

Straight module	Dimension [mm]		
	a	b	c
1.50 SU	37.3	32.5	25
1.25 SU	31.05	26.25	18.75
1.00 SU	24.8	20	12.5

Board drillings

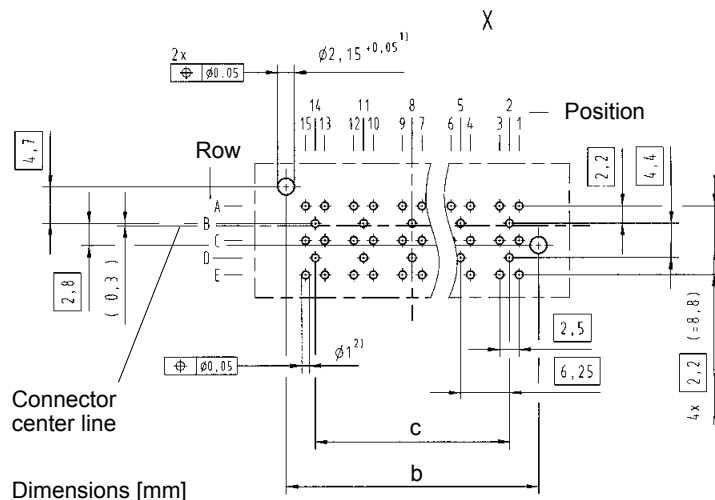

Row B, D: position 2, 5, 8, 11, 14 for signal line
 Row A, C, E: position 1, 3, 4, 6, 7, 9, 10, 12, 13, 15 for ground-line

1) Non-metallised drillings
 2) Details see page 10.07

Dimensions [mm]

Mini Coax

Mini Coax

Standard

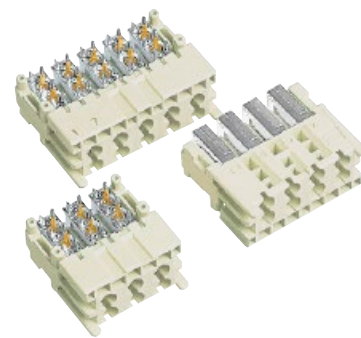

Angled modules

Identification	Number of contacts	SU	loaded positions	Part number
Mini Coax modules, press-in termination	10	1.50	2, 5, 8, 11, 14	07 31 100 0021
	8	1.25	2, 5, 8, 11	07 31 100 0020
	6	1	2, 5, 8	07 31 100 0019
	4	1	2, 8	07 31 900 0022
	2	1	2	07 31 900 0021

Dimensions

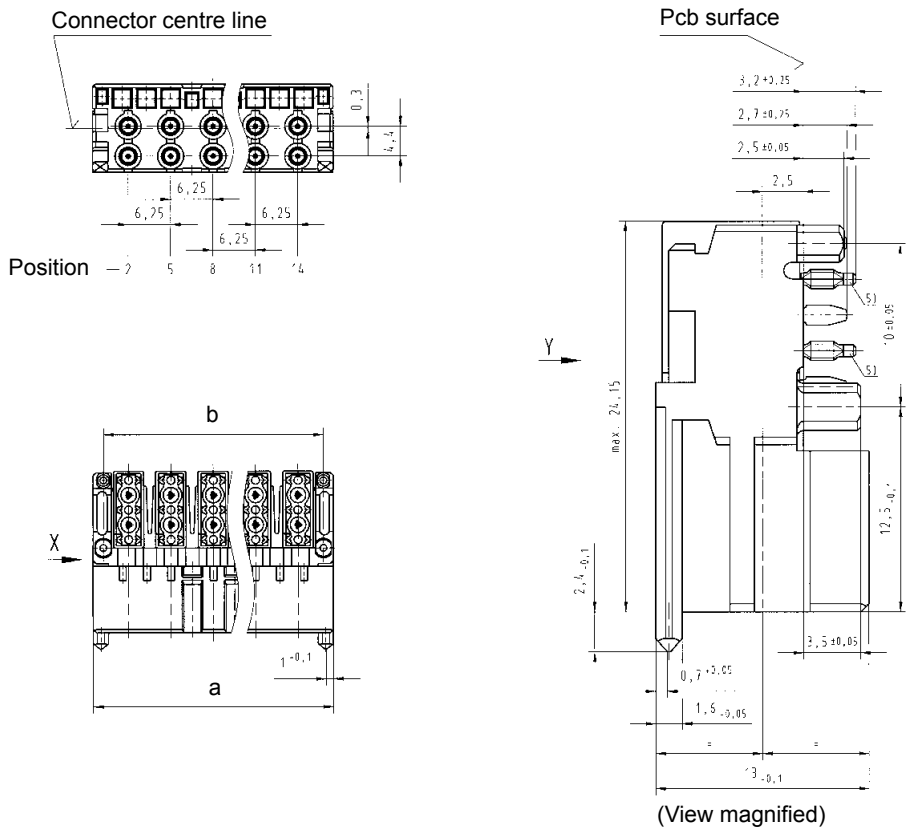

Board drillings

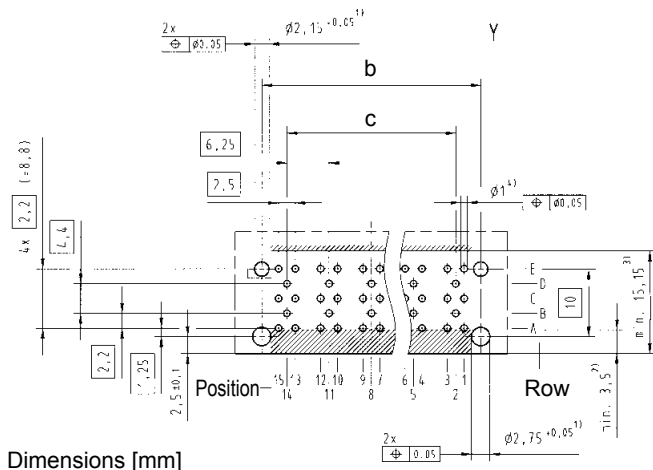

Angled module	Dimension [mm]		
	a	b	c
1.50 SU	35.45	32.5	25
1.25 SU	29.15	26.25	18.75
1.00 SU	22.9	20	12.5

Row B, D: position 2, 5, 8, 11, 14 for signal line
 Row A, C, E: position 1, 3, 4, 6, 7, 9, 10, 12, 13, 15 for ground-line

- 1) Non-metallised drillings
- 2) No tracks, except solder eyes
- 3) Limit area of components (valid for both pcb-sides)
- 4) Details see page 10.07
- 5) Press-in zone in any angular position related to it's longitudinal axis possible

Mini Coax

Mini Coax

General information



The Mini Coax product range also includes various cable assemblies and accessories, which provide customers with flexible application options.

The Mini Coax cable connector is available as plug and socket and is crimped to a coaxial cable that can be individually assembled with RF-cable connectors (SMA, SMB, N-type ...). While delivering high RF transmission performance, the moulded Mini Coax cable assemblies provide robust connections. The various angle mould types meet different cable routing requirements according to the available space. Thanks to various accessories, such as backplane frame, Han® housing insert and press-in cable housing ..., customized connecting requirements can be met.

Remark:

The cable assemblies and accessories shown are part of the overall product range.

Additional, customized parts are available on request.



Mini Coax

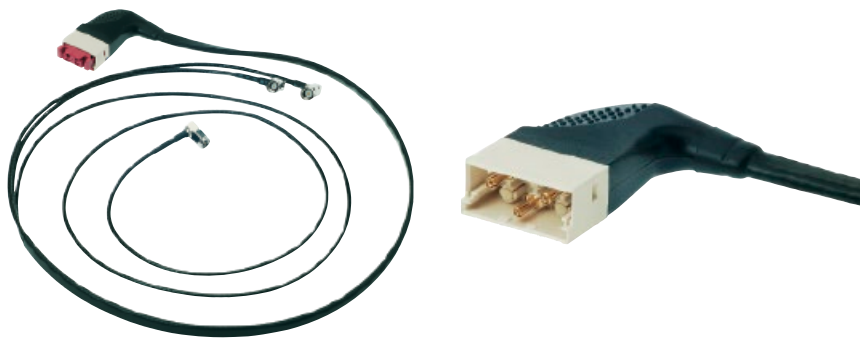

Cable assemblies

Identification	Number of contacts	Part number	Drawing	Dimensions in mm
Cable assembly for mating with the angled standard module	1-10	on request		

Mini Coax

Mini Coax



Cable assemblies

Identification	Part number	Drawing	Dimensions in mm
<p>Cable assembly Mini Coax, 6 position female connector (straight) to SMA crimp connector</p> <p>Hood: overmoulded with top entry</p> <p>Wiring: 1:1</p> <p>Length: L = 0.5 m L = 1.5 m L = 2.0 m</p>	<p>33 07 233 0500 109 33 07 233 1500 110 33 07 233 2000 111</p>		Mini Coax
<p>Cable assembly Mini Coax, 6 pole, male</p> <p>Cable: Mini Coax cable</p> <p>Hood: overmoulded with top entry</p> <p>Wiring: 1:1</p> <p>Length: L = 0.5 m L = 1.5 m L = 2.0 m</p>	<p>33 07 223 0500 112 33 07 223 1500 113 33 07 223 2000 114</p>		

Mini Coax



Assemblies with single-row modules and hoods/housings

Identification	Number of contacts	Part number	Drawing	Dimensions in mm
Cable assembly for mating with the angled single-row module	1-3	on request		
Cable assembly with heavy duty hoods/housings	1-10	on request		

Mini Coax

Mini Coax

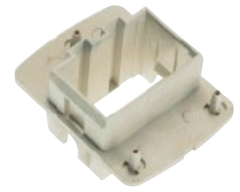

Accessories

Identification	Part number
Backplane frame	07 71 100 0042

Dimensions [mm]

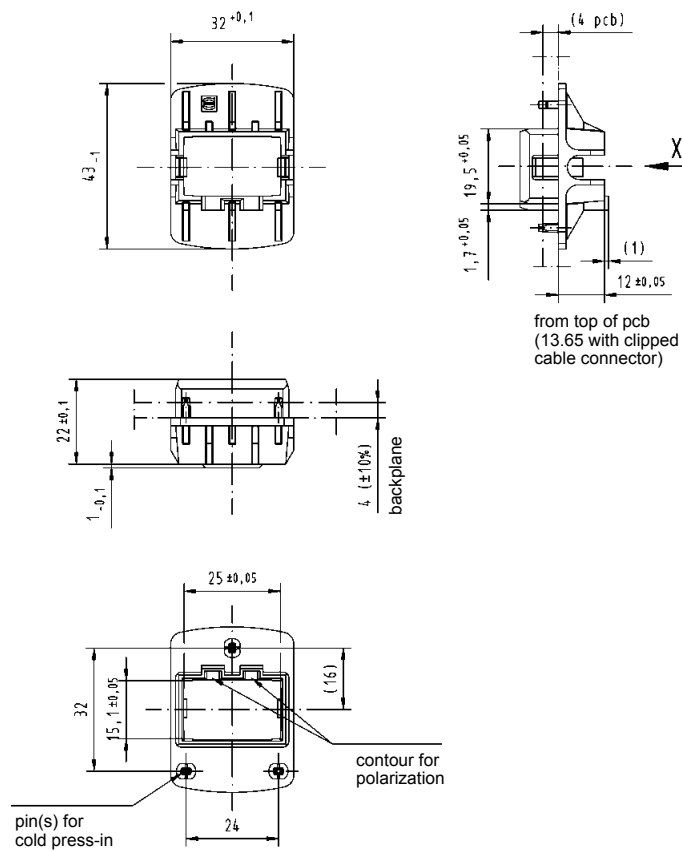

Board drillings

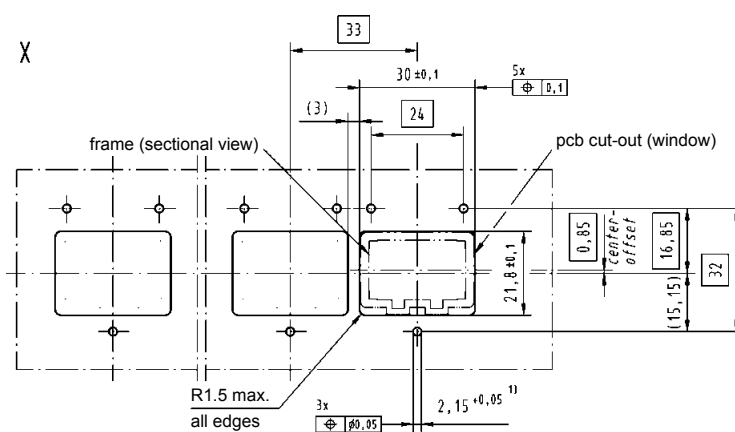

1) Non-metallized drillings

Mini Coax



Accessories

Identification	Part number
Test adapter SMA – Mini Coax	
male for straight modules	07 73 000 0394
female for angled modules	07 73 000 0393

General information

The Mini Coax-to-SMA Adapter can be directly connected to measurement instrument cables. This allows the precise RF transmission characterization of module cards, backplanes and cable assemblies.

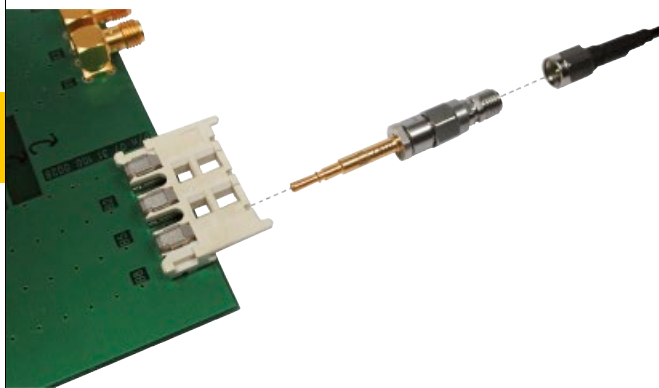

Features:

- SMA connector directly attached to the Mini Coax
- Impedance deviations between adapters < 1.5 Ω
- Good reproducibility of test results
- Test results between different labs are comparable
- Precise measurements of Mini Coax connector system

Electrical characteristics

Mini Coax test adapter	Impedance values @ 31.5 ps rise time at reference plane (10% - 90%):		Max. impedance deviation [Ω]
	Max. [Ω]	Min. [Ω]	
SMA to male	52.5	47.5	1.5
SMA to female	53.5	48.0 40.5*	1.0

Connector	Electrical length [ps]
Mated SMA to male / female adapter	262.2

Frequency [GHz]	Return loss [dB] mated adapter pairs	Insertion loss [dB] mated adapter pairs
< 1	- 26.9	- 0.17
< 2	- 22.5	- 0.24
< 3	- 19.9	- 0.26
< 4	- 16.4	- 0.34
< 5	- 14.4	- 0.42

*: Impedance drop is due to the female Mini Coax connector design.

Dimensions [mm]

Male test adapter

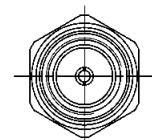
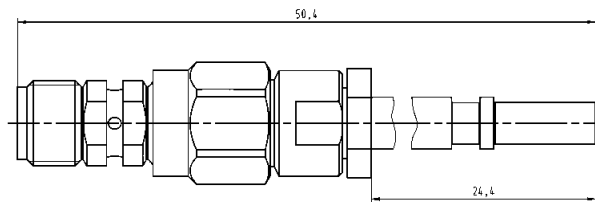
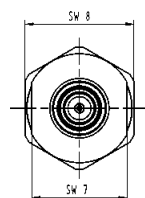

Female test adapter

