



Contents

Page

Han® K 4/4.....	05.8
Han® K 8/24.....	05.10
Han® K 4/0.....	05.13
Han® K 4/2.....	05.15
Han® K 6/12.....	05.17
Han® K 6/36.....	05.19
Han® K 12/2.....	05.22
Han® K 4/8.....	05.25
Han® K 6/6.....	05.27
Han® K 8/0.....	05.29

Han-Com

Summary

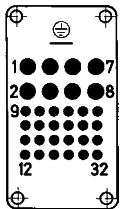
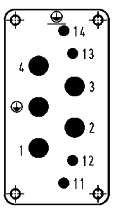
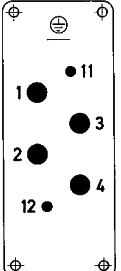
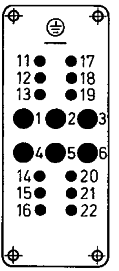
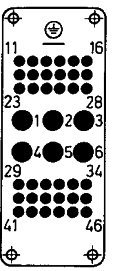
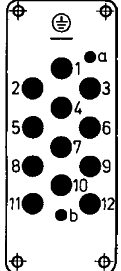
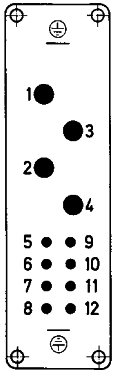
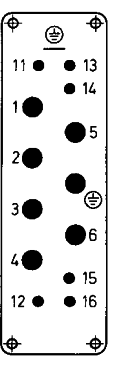
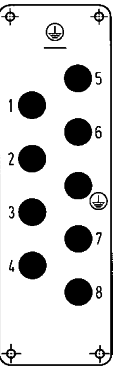

Han-Com

Size	Description
10 B	  <p> Han® K 8/24 16 A / 230/400 V 10 A / 160 V </p> <p> Han® K 4/4 63 A / 690 V 16 A / 230 V </p>
16 B	    <p> Han® K 4/0, 4/2 80 A / 830 V 16 A / 400 V </p> <p> Han® K 6/12 40 A / 690 V 10 A / 230/400 V </p> <p> Han® K 6/36 40 A / 690 V 10 A / 160 V </p> <p> Han® K 12/2 40 A / 690 V 10 A / 250 V </p>
24 B	   <p> Han® K 4/8 80 A / 400 V 16 A / 400 V </p> <p> Han® K 6/6 100 A / 690 V 16 A / 400 V </p> <p> Han® K 8/0 100 A / 690 V </p>
32 B	suitable for 2 inserts of size 16 B
48 B	suitable for 2 inserts of size 24 B

Summary



Summary

Type	Technical characteristics								Suitable Hoods/ Housings
	Power area				Signal area				
	Number of contacts	A	V ~	Termination	Number of contacts	A	V ~	Termination	Size
Han® K 4/0	4+PE	80	830	screw	—	—	—	—	16 B, 32 B
Han® K 4/2	4+PE	80	830	screw	2	16	400	screw	16 B, 32 B
Han® K 4/4	4+PE	63	690	axial screw	4	16	250	cage clamp	10 B
Han® K 4/8	4+PE	80	400	screw	8	16	400	screw	24 B, 48 B
Han® K 6/6	6+PE	100	690	axial screw	6	16	400	screw	24 B, 48 B
Han® K 6/12	6+PE	40	690	axial screw	12	10	230/400	screw	16 B, 32 B
Han® K 6/36	6+PE	40	690	crimp	36	10	160	crimp	16 B, 32 B
Han® K 8/0	8+PE	100	690	axial screw	—	—	—	—	24 B, 48 B
Han® K 8/24	8+PE	16	230/400	crimp	24	10	160	crimp	10 B
Han® K 12/2	12+PE	40	690	crimp	2	10	250	crimp	16 B, 32 B

Han-Com

Type identification

Han® K 6/12

Han® Industrial connectors Han®
 K Series Han® K / Han-Com®
 6 Number of power contacts
 12 Number of signal contacts

Identification of contact position

Han® K connectors from 1 to ... (power area)
 from 11 to... (signal area)

Exceptions
 Han® K 4/8 and Han® K 8/24 from 1 to ... (consecutively)
 Han® K 12/2 from 1 to 12 (power area)
 with „a“ and „b“ (signal area)

Comment for users

For the combination of several circuits in one cable and/or e.g. one connector the following standards are valid:
 DIN VDE 0100-410/06.2007 § 411.3.1.1 and DIN EN 60 204/06.2007 § 13.1.3

Accessories

Crimping tools chapter 90
 Cable clamps chapter 80
 Coding of hoods/housings chapter 80
 Label acc. to CSA-approval chapter 80
 Han-Snap® chapter 11
 PCB adapter chapter 80

Assembly instructions Han[®] K 4/4



Han-Com

Description

Depiction

Dimensions in mm

Step 1:

Signal contacts:
Push screwdriver (0.5 x 3.5) into rectangular chamber. Strip insulation from the wire with a length and insert the wire into the round contact chamber.

Power contacts:
Strip insulation from the wire with a length and insert the wire into the contact chamber until insulation is flush with contact. Do not twist the strands of the wire.

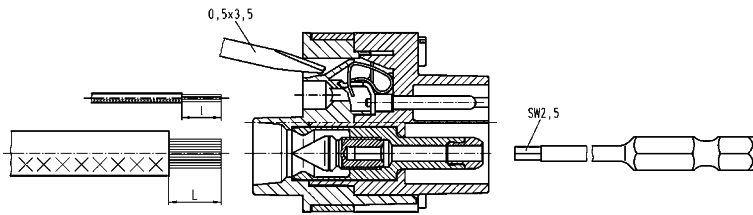

I: Stripping length for signal contacts

L: Stripping length for power contacts

Step 2:

Signal contacts:
Push screwdriver (0.5 x 3.5) out of rectangular chamber.

Power contacts:
Hold the wire in position and tighten by a hexagonal driver (SW 2.5) from the mating side with a tightening torque.

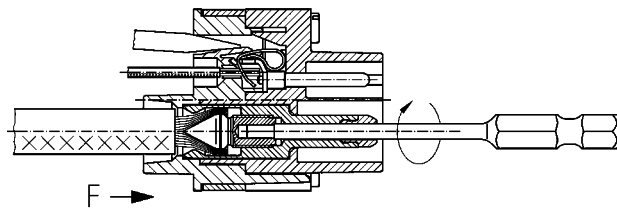

Step 3:

Complete connection

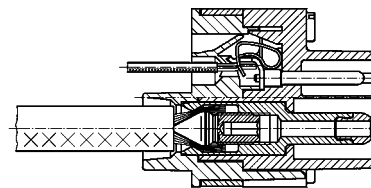

Assembly instructions Han® K 6/12



Description

Depiction

Dimensions in mm

Step 1:

Signal contacts:

Strip insulation from the wire with a length and insert the wire into the rectangular contact chamber.

Power contacts:

Strip insulation from the wire with a length until insulation is flush with contact. Do not twist the strands of the wire.

Step 2:

Signal contacts:

Tighten screw termination with screwdriver (0.5 x 3.5) with a tightening torque.

Power contacts:

Hold the wire in position and tighten by a hexagonal driver (SW 2) from the mating side with a tightening torque.

Step 3:

Complete connection

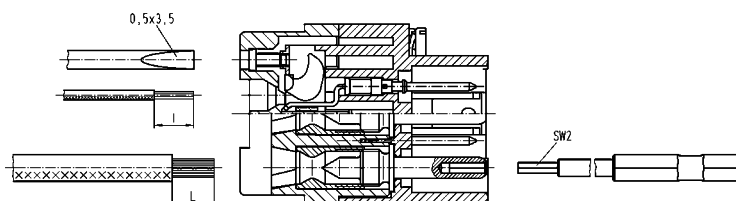

I: Stripping length for signal contacts

L: Stripping length for power contacts

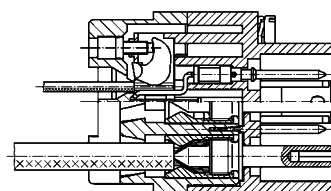
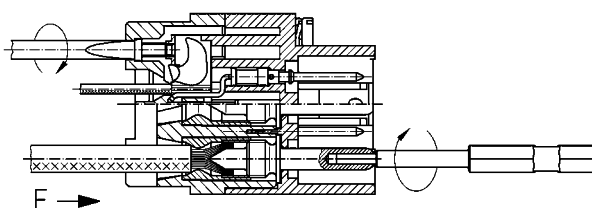

Han-Com

Assembly instructions Han® K 8/0



Description

Depiction

Dimensions in mm

Step 1:
Strip insulation from the wire with a length and insert the wire into the contact chamber until insulation is flush with contact. Do not twist the strands of the wire.

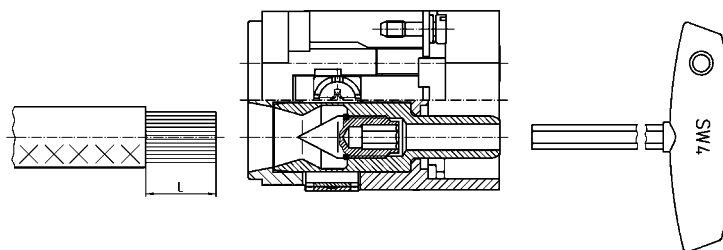

L: Stripping length for power contacts

Step 2:
Hold the wire in position and tighten by a hexagonal driver (SW 4) from the mating side with a tightening torque.

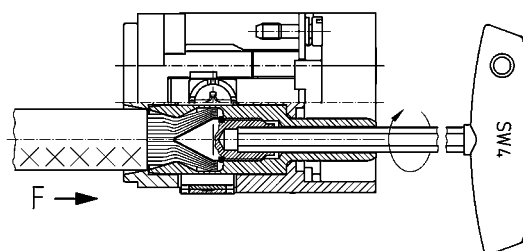

Step 3:
Complete connection

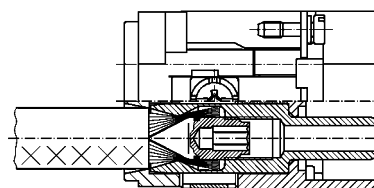

Han-Com

Han® K 4/4



Features

- Combination of power and signal area in one connector
- Axial screw termination for power area
- Cage clamp termination for signal area
- Same range of wire cross section for PE contacts and power contacts

Derating

Current carrying capacity

The current carrying capacity of the connectors is limited by the thermal load capability of the contact element material including the connections and the insulating parts. The derating curve is therefore valid for currents which flow constantly (non-intermittent) through each contact element of the connector evenly, without exceeding the allowed maximum temperature. Measuring and testing techniques acc. to IEC 60512-5-2

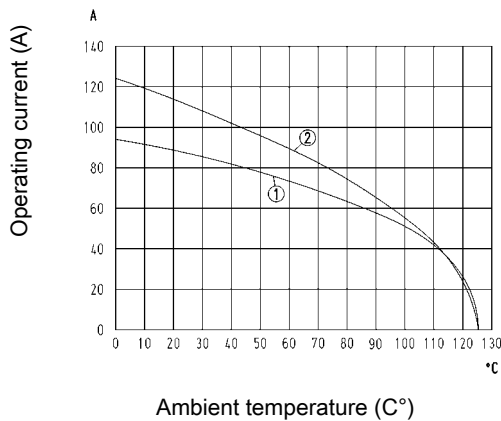

- ① Wire cross section 16 mm²
- ② Wire cross section 22 mm²

Technical characteristics

Contacts	4/4
Electrical data acc. to IEC 61984	63 A 690 V 8 kV 3
Rated current	63 A
Rated voltage	690 V
Rated impulse voltage	8 kV
Pollution degree	3
Electrical data, signal	16 A 250 V 4 kV 3
Rated current	16 A
Rated voltage	250 V
Rated impulse voltage	4 kV
Rated voltage acc. to UL	600 V
Rated voltage acc. to UL, signal	230 V
Insulation resistance	≥10 ¹⁰ Ohm
Limiting temperatures	-40 °C ... 125 °C
Flammability (insert) acc. to UL 94	V 0
Mating cycles	≥500
Material (insert)	polycarbonate
Colour (insert)	RAL 7032 (light grey)
Material (contact)	copper alloy
Material (contact, signal area)	copper alloy
Hex key	SW 2.5

Specifications and approvals

IEC 60664-1
IEC 61984



Details

Hoods/Housings see chapter 31

Hex key 09 99 000 0375 see chapter 90

Remarks on the axial screw technique

The wire gauges mentioned in the catalogue refer to geometric wire gauges of cables.

Han® K 4/4

Size 10 B



Number of contacts

4/4+

690 V / 250 V
63 A/16 A

Identification	Wire cross section (mm²)	Part number		Drawing Dimensions in mm
		male	female	

Han-Com®, Axial screw terminal / Cage-clamp terminal, silver plated contacts, contact resistance ≤0.5 mOhm contact resistance, signal ≤3 mOhm

finger safe

6-16	09 38 008 2601	09 38 008 2701
10-22	09 38 008 2602	09 38 008 2702

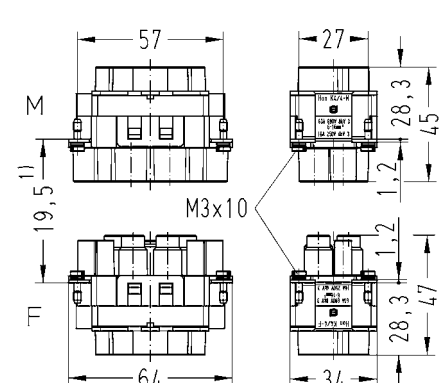

1) Distance for contact max. 21 mm

Han-Com®, Axial screw terminal / Cage-clamp terminal, silver plated contacts, contact resistance ≤0.5 mOhm contact resistance, signal ≤3 mOhm

not finger safe

6-16	09 38 008 2611	
10-22	09 38 008 2612	

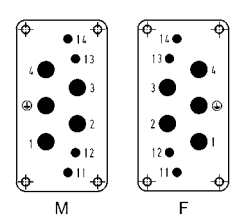

Contact arrangement (view from termination side)

power contacts			
wire gauge	tightening torque	stripping length	max. insulation diameter
6 mm²	2 Nm	11 ... 12 mm	8.9 mm
10 mm²	3 Nm	11 ... 12 mm	8.9 mm
16 mm²	4 Nm	11 ... 12 mm	8.9 mm
22 mm²	4 Nm	13 ... 14 mm	11mm

Signal contacts :
Wire cross section 0.14 ... 2.5 mm²
Stripping length 7 ... 9 mm

Han-Com

Han® K 8/24



Features

- Combination of power and signal area in one connector
- Crimp termination for power and signal area
- Use of standard Han E® and Han D® contacts

Derating

Current carrying capacity

The current carrying capacity of the connectors is limited by the thermal load capability of the contact element material including the connections and the insulating parts. The derating curve is therefore valid for currents which flow constantly (non-intermittent) through each contact element of the connector evenly, without exceeding the allowed maximum temperature.

Measuring and testing techniques acc. to IEC 60512-5-2

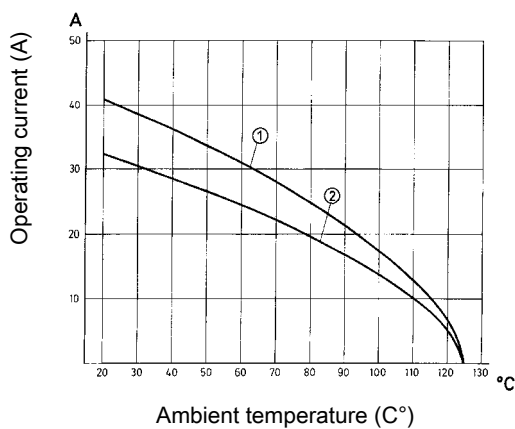

- ① Wire cross section 4 mm²
- ② Wire cross section 2.5 mm²

Technical characteristics

Contacts	8/24
Electrical data acc. to IEC 61984	16 A 230/400 V 4 kV 3
Rated current	16 A
Rated voltage conductor - ground	230 V
Rated voltage conductor - conductor	400 V
Rated impulse voltage	4 kV
Pollution degree	3
Electrical data, signal	10 A 160 V 2.5 kV 3
Rated current	10 A
Rated voltage	160 V
Rated impulse voltage	2.5 kV
Rated voltage acc. to UL	600 V
Rated voltage acc. to UL, signal	600 V
Rated voltage acc. to CSA	300 V
Rated voltage acc. to CSA, signal	300 V
Insulation resistance	≥10 ¹⁰ Ohm
Limiting temperatures	-40 °C ... 125 °C
Flammability (insert) acc. to UL 94	HB
Mating cycles	≥500
Material (insert)	polyamide
Colour (insert)	RAL 7032 (light grey)
Material (contact)	copper alloy
Material (contact, signal area)	copper alloy

Specifications and approvals

IEC 60664-1
IEC 61984



Details

Hoods/Housings see chapter 31

Crimping tools see chapter 90

Remarks on the crimp technique

The wire gauges mentioned in the catalogue refer to geometric wire gauges of cables.

Removal of power contacts (Han E®)

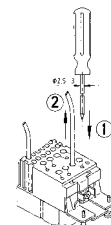

- ① Push cross-slotted screw driver (size 0) in the relevant hole of the contact until it reaches the bottom
- ② Withdraw the crimped contact from the insert

Han-Com

Han® K 8/24





Size 10 B

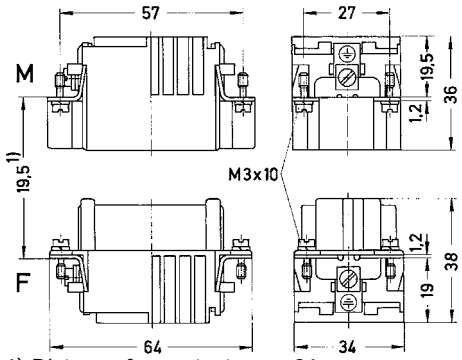
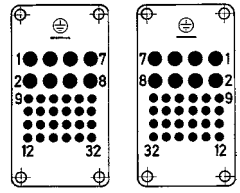

Number of contacts

8/24+

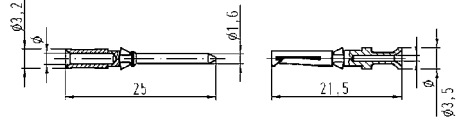
230/400 V / 160 V
16 A/10 A

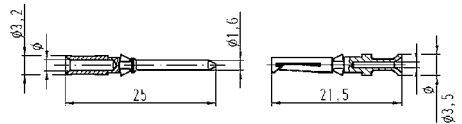
Identification	Wire cross section (mm ²)	Part number		Drawing Dimensions in mm																					
		male	female																						
Han-Com®, Crimp terminal  Please order crimp contacts separately.		09 38 032 3001	09 38 032 3101	 1) Distance for contact max. 21 mm  Contact arrangement (view from termination side)																					
Han D®, Crimp contact, gold plated contacts, contact resistance ≤3 mOhm 	0.14–0.37 0.5 0.75 1 1.5 2.5	09 15 000 6124 09 15 000 6123 09 15 000 6125 09 15 000 6122 09 15 000 6121 09 15 000 6126	09 15 000 6224 09 15 000 6223 09 15 000 6225 09 15 000 6222 09 15 000 6221 09 15 000 6226	 <table border="1"> <thead> <tr> <th>Wire gauge</th> <th>ø</th> <th>Stripping length</th> </tr> </thead> <tbody> <tr> <td>0.14-0.37 mm² AWG 26-22</td> <td>0.9 mm</td> <td>8 mm</td> </tr> <tr> <td>0.5 mm² AWG 20</td> <td>1.1 mm</td> <td>8 mm</td> </tr> <tr> <td>0.75 mm² AWG 18</td> <td>1.3 mm</td> <td>8 mm</td> </tr> <tr> <td>1 mm² AWG 18</td> <td>1.45 mm</td> <td>8 mm</td> </tr> <tr> <td>1.5 mm² AWG 16</td> <td>1.75 mm</td> <td>8 mm</td> </tr> <tr> <td>2.5 mm² AWG 14</td> <td>2.25 mm</td> <td>6 mm</td> </tr> </tbody> </table>	Wire gauge	ø	Stripping length	0.14-0.37 mm ² AWG 26-22	0.9 mm	8 mm	0.5 mm ² AWG 20	1.1 mm	8 mm	0.75 mm ² AWG 18	1.3 mm	8 mm	1 mm ² AWG 18	1.45 mm	8 mm	1.5 mm ² AWG 16	1.75 mm	8 mm	2.5 mm ² AWG 14	2.25 mm	6 mm
Wire gauge	ø	Stripping length																							
0.14-0.37 mm ² AWG 26-22	0.9 mm	8 mm																							
0.5 mm ² AWG 20	1.1 mm	8 mm																							
0.75 mm ² AWG 18	1.3 mm	8 mm																							
1 mm ² AWG 18	1.45 mm	8 mm																							
1.5 mm ² AWG 16	1.75 mm	8 mm																							
2.5 mm ² AWG 14	2.25 mm	6 mm																							
Han D®, Crimp contact, silver plated contacts, contact resistance ≤3 mOhm 	0.14–0.37 0.5 0.75 1 1.5 2.5	09 15 000 6104 09 15 000 6103 09 15 000 6105 09 15 000 6102 09 15 000 6101 09 15 000 6106	09 15 000 6204 09 15 000 6203 09 15 000 6205 09 15 000 6202 09 15 000 6201 09 15 000 6206	 <table border="1"> <thead> <tr> <th>Wire gauge</th> <th>ø</th> <th>Stripping length</th> </tr> </thead> <tbody> <tr> <td>0.14-0.37 mm² AWG 26-22</td> <td>0.9 mm</td> <td>8 mm</td> </tr> <tr> <td>0.5 mm² AWG 20</td> <td>1.1 mm</td> <td>8 mm</td> </tr> <tr> <td>0.75 mm² AWG 18</td> <td>1.3 mm</td> <td>8 mm</td> </tr> <tr> <td>1 mm² AWG 18</td> <td>1.45 mm</td> <td>8 mm</td> </tr> <tr> <td>1.5 mm² AWG 16</td> <td>1.75 mm</td> <td>8 mm</td> </tr> <tr> <td>2.5 mm² AWG 14</td> <td>2.25 mm</td> <td>6 mm</td> </tr> </tbody> </table>	Wire gauge	ø	Stripping length	0.14-0.37 mm ² AWG 26-22	0.9 mm	8 mm	0.5 mm ² AWG 20	1.1 mm	8 mm	0.75 mm ² AWG 18	1.3 mm	8 mm	1 mm ² AWG 18	1.45 mm	8 mm	1.5 mm ² AWG 16	1.75 mm	8 mm	2.5 mm ² AWG 14	2.25 mm	6 mm
Wire gauge	ø	Stripping length																							
0.14-0.37 mm ² AWG 26-22	0.9 mm	8 mm																							
0.5 mm ² AWG 20	1.1 mm	8 mm																							
0.75 mm ² AWG 18	1.3 mm	8 mm																							
1 mm ² AWG 18	1.45 mm	8 mm																							
1.5 mm ² AWG 16	1.75 mm	8 mm																							
2.5 mm ² AWG 14	2.25 mm	6 mm																							

Han-Com

Han® K 8/24

Size 10 B



Han-Com

Identification	Wire cross section (mm ²)	Part number	
		male	female
Han E®, Crimp contact, gold plated contacts, contact resistance ≤1 mOhm	0.5	09 33 000 6122	09 33 000 6222
	0.75	09 33 000 6115	09 33 000 6215
	1	09 33 000 6118	09 33 000 6218
	1.5	09 33 000 6116	09 33 000 6216
	2.5	09 33 000 6123	09 33 000 6223
	4	09 33 000 6119	09 33 000 6221

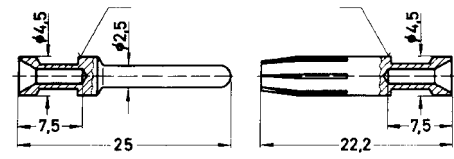

Identification	Wire gauge	Stripping length
no groove	0.14-0.37 mm ² AWG 26-22	7.5 mm
no groove	0.5 mm ² AWG 20	7.5 mm
1 groove*	0.75 mm ² AWG 18	7.5 mm
1 groove	1 mm ² AWG 18	7.5 mm
2 grooves	1.5 mm ² AWG 16	7.5 mm
3 grooves	2.5 mm ² AWG 14	7.5 mm
wide groove	3 mm ² AWG 12	7.5 mm
no groove	4 mm ² AWG 12	7.5 mm

* on the back crimp collar

Identification	Wire cross section (mm ²)	Part number	
		male	female
Han E®, Crimp contact, silver plated contacts, contact resistance ≤1 mOhm	0.5	09 33 000 6121	09 33 000 6220
	0.75	09 33 000 6114	09 33 000 6214
	1	09 33 000 6105	09 33 000 6205
	1.5	09 33 000 6104	09 33 000 6204
	2.5	09 33 000 6102	09 33 000 6202
	4	09 33 000 6107	09 33 000 6207

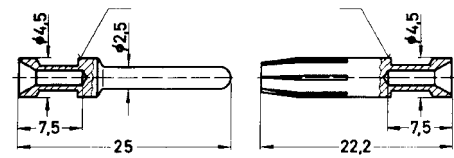

Identification	Wire gauge	Stripping length
no groove	0.14-0.37 mm ² AWG 26-22	7.5 mm
no groove	0.5 mm ² AWG 20	7.5 mm
1 groove*	0.75 mm ² AWG 18	7.5 mm
1 groove	1 mm ² AWG 18	7.5 mm
2 grooves	1.5 mm ² AWG 16	7.5 mm
3 grooves	2.5 mm ² AWG 14	7.5 mm
wide groove	3 mm ² AWG 12	7.5 mm
no groove	4 mm ² AWG 12	7.5 mm

* on the back crimp collar

Identification	Wire cross section (mm ²)	Part number	
		male	female
Han E®, Relay contact, silver plated contacts, contact resistance ≤1 mOhm	0.75 - 1	09 33 000 6109	
	1.5	09 33 000 6110	
	2.5	09 33 000 6111	

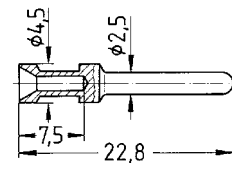

Stripping length 7.5 mm

Identification	Wire cross section (mm ²)	Part number	Part number
F.O. contact for 1 mm plastic fibre		20 10 001 3211	20 10 001 3221

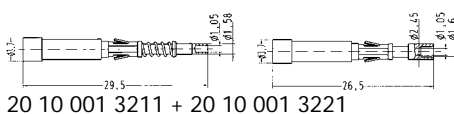

20 10 001 3211 + 20 10 001 3221

Han® K 4/0



Features

- Screw terminal
- No signal contacts

Derating

Current carrying capacity

The current carrying capacity of the connectors is limited by the thermal load capability of the contact element material including the connections and the insulating parts. The derating curve is therefore valid for currents which flow constantly (non-intermittent) through each contact element of the connector evenly, without exceeding the allowed maximum temperature.

Measuring and testing techniques acc. to IEC 60512-5-2

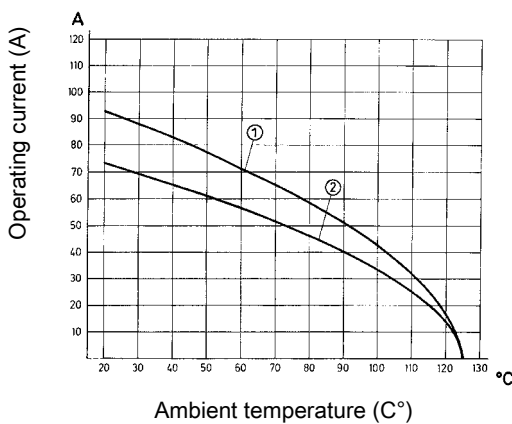

- ① Wire cross section 16 mm²
- ② Wire cross section 10 mm²

Technical characteristics

Contacts	4/0
Electrical data acc. to IEC 61984	80 A 830 V 8 kV 3
Rated current	80 A
Rated voltage	830 V
Rated impulse voltage	8 kV
Pollution degree	3
Rated voltage acc. to UL	600 V
Rated voltage acc. to CSA	300 V
Insulation resistance	≥10 ¹⁰ Ohm
Limiting temperatures	-40 °C ... 125 °C
Flammability (insert) acc. to UL 94	V 0
Mating cycles	<500
Material (insert)	polycarbonate
Colour (insert)	RAL 7032 (light grey)
Material (contact)	copper alloy

Specifications and approvals

IEC 60664-1
IEC 61984



Details

Hoods/Housings see chapter 31

In accordance with the appropriate regulations a wire-end sleeve has to be used at clamps without wire protection (see "screw terminal", chapter 00).

Han-Com

Han® K 4/0

Size 16 B



Number of contacts

4/0+

830 V
80 A

Han-Com

Han-Com®,
Screw terminal,
silver plated contacts,
contact resistance ≤0.3 mOhm



Wire cross section (mm²)

1.5 – 16

Part number

male

female

09 38 006 2611

09 38 006 2711

Drawing
Dimensions in mm

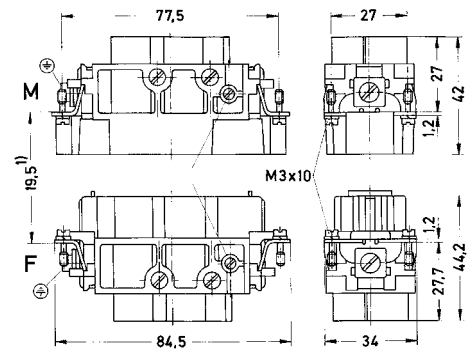

1) Distance for contact max. 21 mm

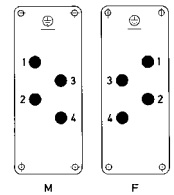

Contact arrangement (view from termination side)

power contacts		
wire gauge	tightening torque	stripping length
1.5 mm²	1.2 Nm	14 mm
2.5 mm²	2 Nm	14 mm
4 mm²	3 Nm	14 mm
6 mm²	3 Nm	14 mm
10 mm²	3 Nm	14 mm
16 mm²	3 Nm	14 mm

Han® K 4/2



Features

- Combination of power and signal area in one connector
- Screw termination for power and signal area

Derating

Current carrying capacity

The current carrying capacity of the connectors is limited by the thermal load capability of the contact element material including the connections and the insulating parts. The derating curve is therefore valid for currents which flow constantly (non-intermittent) through each contact element of the connector evenly, without exceeding the allowed maximum temperature.

Measuring and testing techniques acc. to IEC 60512-5-2

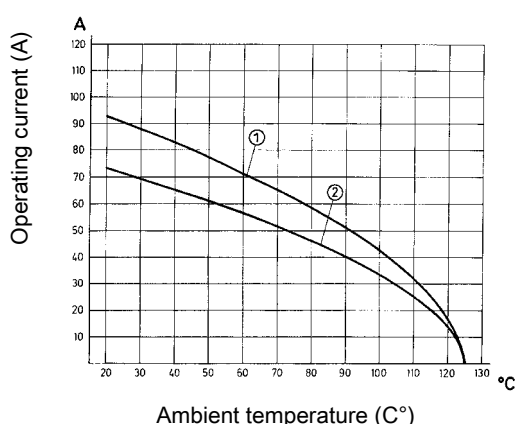

- ① Wire cross section 16 mm²
- ② Wire cross section 10 mm²

Technical characteristics

Contacts	4/2
Electrical data acc. to IEC 61984	80 A 830 V 8 kV 3
Rated current	80 A
Rated voltage	830 V
Rated impulse voltage	8 kV
Pollution degree	3
Electrical data, signal	16 A 400 V 6 kV 3
Rated current	16 A
Rated voltage	400 V
Rated impulse voltage	6 kV
Rated voltage acc. to UL	600 V
Rated voltage acc. to UL, signal	600 V
Rated voltage acc. to CSA	300 V
Rated voltage acc. to CSA, signal	300 V
Insulation resistance	≥10 ¹⁰ Ohm
Limiting temperatures	-40 °C ... 125 °C
Flammability (insert) acc. to UL 94	V 0
Mating cycles	≥500
Material (insert)	polycarbonate
Colour (insert)	RAL 7032 (light grey)
Material (contact)	copper alloy
Material (contact, signal area)	copper alloy

Han-Com

Specifications and approvals

IEC 60664-1
IEC 61984



Details

Hoods/Housings see chapter 31

In accordance with the appropriate regulations a wire-end sleeve has to be used at clamps without wire protection (see "screw terminal", chapter 00).

Han® K 4/2

Size 16 B



Number of contacts

4/2+

830 V / 400 V
80 A/16 A

Han-Com

Identification	Wire cross section (mm ²)	Part number		Drawing Dimensions in mm																								
		male	female																									
Han-Com®, Screw terminal / Screw terminal, silver plated contacts, contact resistance ≤0.3 mOhm contact resistance, signal ≤1 mOhm 	1.5 - 16	09 38 006 2601	09 38 006 2701	<p>1) Distance for contact max. 21 mm</p> <p>11 ● 1 3 ● 2 12 ● 4</p> <p>11 ● 1 3 ● 2 12 ● 4</p> <p>M F</p> <p>Contact arrangement (view from termination side)</p> <table border="1"> <thead> <tr> <th colspan="3">power contacts</th> </tr> <tr> <th>wire gauge</th> <th>tightening torque</th> <th>stripping length</th> </tr> </thead> <tbody> <tr> <td>1.5 mm²</td> <td>1.2 Nm</td> <td>14 mm</td> </tr> <tr> <td>2.5 mm²</td> <td>2 Nm</td> <td>14 mm</td> </tr> <tr> <td>4 mm²</td> <td>3 Nm</td> <td>14 mm</td> </tr> <tr> <td>6 mm²</td> <td>3 Nm</td> <td>14 mm</td> </tr> <tr> <td>10 mm²</td> <td>3 Nm</td> <td>14 mm</td> </tr> <tr> <td>16 mm²</td> <td>3 Nm</td> <td>14 mm</td> </tr> </tbody> </table> <p>Signal contacts : Wire cross section 0.5 ... 2.5 mm² Stripping length 7.5 mm</p>	power contacts			wire gauge	tightening torque	stripping length	1.5 mm ²	1.2 Nm	14 mm	2.5 mm ²	2 Nm	14 mm	4 mm ²	3 Nm	14 mm	6 mm ²	3 Nm	14 mm	10 mm ²	3 Nm	14 mm	16 mm ²	3 Nm	14 mm
power contacts																												
wire gauge	tightening torque	stripping length																										
1.5 mm ²	1.2 Nm	14 mm																										
2.5 mm ²	2 Nm	14 mm																										
4 mm ²	3 Nm	14 mm																										
6 mm ²	3 Nm	14 mm																										
10 mm ²	3 Nm	14 mm																										
16 mm ²	3 Nm	14 mm																										

Han® K 6/12



Features

- Combination of power and signal area in one connector
- Axial screw termination for power area
- Screw termination for signal area

Derating

Current carrying capacity

The current carrying capacity of the connectors is limited by the thermal load capability of the contact element material including the connections and the insulating parts. The derating curve is therefore valid for currents which flow constantly (non-intermittent) through each contact element of the connector evenly, without exceeding the allowed maximum temperature.

Measuring and testing techniques acc. to IEC 60512-5-2

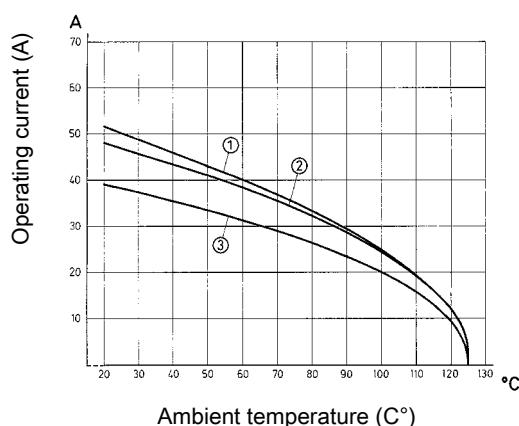

- ① Wire cross section 10 mm²
- ② Wire cross section 6 mm²
- ③ Wire cross section 4 mm²

Technical characteristics

Contacts	6/12
Electrical data acc. to IEC 61984	40 A 690 V 8 kV 3
Rated current	40 A
Rated voltage	690 V
Rated impulse voltage	8 kV
Pollution degree	3
Electrical data, signal	10 A 230/400 V 4 kV 3
Rated current	10 A
Rated voltage conductor - ground	230 V
Rated voltage conductor - conductor	400 V
Rated impulse voltage	4 kV
Rated voltage acc. to UL	600 V
Rated voltage acc. to UL, signal	600 V
Rated voltage acc. to CSA	300 V
Rated voltage acc. to CSA, signal	300 V
Insulation resistance	≥10 ¹⁰ Ohm
Limiting temperatures	-40 °C ... 125 °C
Flammability (insert) acc. to UL 94	V 0
Mating cycles	≥500
Material (insert)	polycarbonate
Colour (insert)	RAL 7032 (light grey)
Material (contact)	copper alloy
Material (contact, signal area)	copper alloy
Hex key	SW 2

Han-Com

Specifications and approvals

IEC 60664-1
IEC 61984



Details

Hoods/Housings see chapter 31

Hex key adapter 1/4" 09 99 000 0369 see chapter 90

Remarks on the axial screw technique

The wire gauges mentioned in the catalogue refer to geometric wire gauges of cables.

Han® K 6/12

Size 16 B



Number of contacts

6/12+

690 V / 230/400 V
40 A/10 A

Han-Com

Han-Com®, Axial screw terminal / Screw terminal, silver plated contacts, contact resistance ≤0.5 mOhm contact resistance, signal ≤3 mOhm



Wire cross section (mm²)

2.5-8
6-10

Part number

male

female

09 38 018 2601
09 38 018 2602

09 38 018 2701
09 38 018 2702

Drawing Dimensions in mm

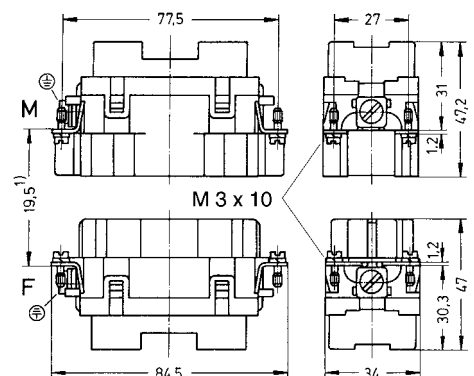

1) Distance for contact max. 21 mm

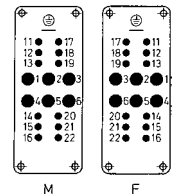

Contact arrangement (view from termination side)

power contacts			
wire gauge	tightening torque	stripping length	max. insulation diameter
2.5 mm²	1.5 Nm	8 ... 9 mm	6.1 mm
4 mm²	1.5 Nm	8 ... 9 mm	6.1 mm
6 mm²	2 Nm	8 ... 9 mm	6.1 mm
10 mm²	2 Nm	8 ... 9 mm	6.1 mm

Signal contacts :
Wire cross section 0.2 ... 2.5 mm²
Stripping length 7.5 mm

Han® K 6/36



Features

- Combination of power and signal area in one connector
- Crimp termination for power and signal area
- Use of standard Han® C and Han D® contacts

Derating

Current carrying capacity

The current carrying capacity of the connectors is limited by the thermal load capability of the contact element material including the connections and the insulating parts. The derating curve is therefore valid for currents which flow constantly (non-intermittent) through each contact element of the connector evenly, without exceeding the allowed maximum temperature.

Measuring and testing techniques acc. to IEC 60512-5-2

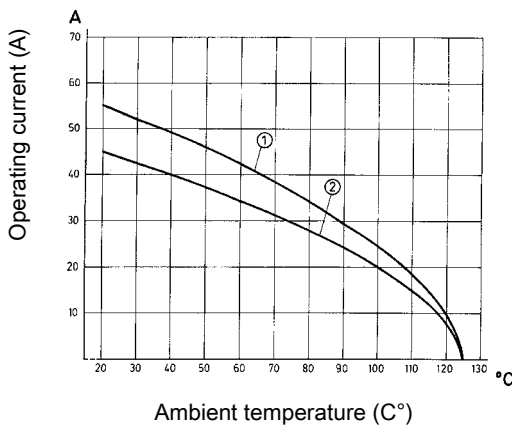

- ① Wire cross section 6 mm²
- ② Wire cross section 4 mm²

Technical characteristics

Contacts	6/36
Electrical data acc. to IEC 61984	40 A 690 V 8 kV 3
Rated current	40 A
Rated voltage	690 V
Rated impulse voltage	8 kV
Pollution degree	3
Electrical data, signal	10 A 160 V 2.5 kV 3
Rated current	10 A
Rated voltage	160 V
Rated impulse voltage	2.5 kV
Rated voltage acc. to UL	600 V
Rated voltage acc. to UL, signal	600 V
Rated voltage acc. to CSA	300 V
Rated voltage acc. to CSA, signal	300 V
Insulation resistance	≥10 ¹⁰ Ohm
Limiting temperatures	-40 °C ... 125 °C
Flammability (insert) acc. to UL 94	V 0
Mating cycles	≥500
Material (insert)	polycarbonate
Colour (insert)	RAL 7032 (light grey)
Material (contact)	copper alloy
Material (contact, signal area)	copper alloy

Han-Com

Specifications and approvals

IEC 60664-1
IEC 61984



Details

Hoods/Housings see chapter 31

Crimping tools see chapter 90

Remarks on the crimp technique

The wire gauges mentioned in the catalogue refer to geometric wire gauges of cables.

Han® K 6/36

Size 16 B







Number of contacts

6/36+

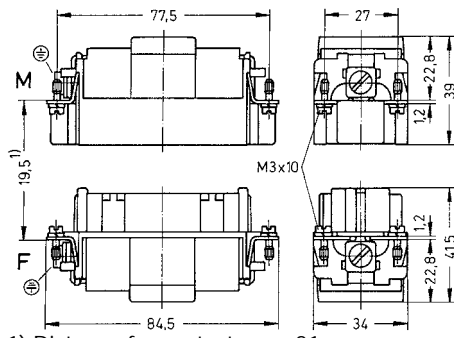
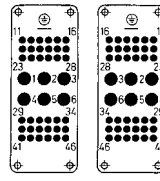
690 V / 160 V
40 A/10 A

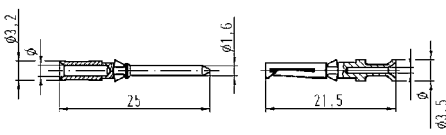

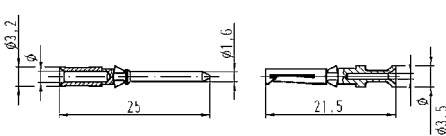
Han-Com

Identification	Wire cross section (mm²)	Part number		Drawing																					
		male	female	Dimensions in mm																					
<p>Han-Com®, Crimp/crimp terminal</p>  <p>Please order crimp contacts separately.</p>		09 38 042 3001	09 38 042 3101	 <p>1) Distance for contact max. 21 mm Max. insulation diameter 5 mm</p>  <p>Contact arrangement (view from termination side)</p>																					
<p>Han D®, Crimp contact, gold plated contacts, contact resistance ≤3 mOhm</p> 	0.14–0.37 0.5 0.75 1 1.5 2.5	09 15 000 6124 09 15 000 6123 09 15 000 6125 09 15 000 6122 09 15 000 6121 09 15 000 6126	09 15 000 6224 09 15 000 6223 09 15 000 6225 09 15 000 6222 09 15 000 6221 09 15 000 6226	 <table border="1"> <thead> <tr> <th>Wire gauge</th> <th>∅</th> <th>Stripping length</th> </tr> </thead> <tbody> <tr> <td>0.14-0.37 mm² AWG 26-22</td> <td>0.9 mm</td> <td>8 mm</td> </tr> <tr> <td>0.5 mm² AWG 20</td> <td>1.1 mm</td> <td>8 mm</td> </tr> <tr> <td>0.75 mm² AWG 18</td> <td>1.3 mm</td> <td>8 mm</td> </tr> <tr> <td>1 mm² AWG 18</td> <td>1.45 mm</td> <td>8 mm</td> </tr> <tr> <td>1.5 mm² AWG 16</td> <td>1.75 mm</td> <td>8 mm</td> </tr> <tr> <td>2.5 mm² AWG 14</td> <td>2.25 mm</td> <td>6 mm</td> </tr> </tbody> </table>	Wire gauge	∅	Stripping length	0.14-0.37 mm² AWG 26-22	0.9 mm	8 mm	0.5 mm² AWG 20	1.1 mm	8 mm	0.75 mm² AWG 18	1.3 mm	8 mm	1 mm² AWG 18	1.45 mm	8 mm	1.5 mm² AWG 16	1.75 mm	8 mm	2.5 mm² AWG 14	2.25 mm	6 mm
Wire gauge	∅	Stripping length																							
0.14-0.37 mm² AWG 26-22	0.9 mm	8 mm																							
0.5 mm² AWG 20	1.1 mm	8 mm																							
0.75 mm² AWG 18	1.3 mm	8 mm																							
1 mm² AWG 18	1.45 mm	8 mm																							
1.5 mm² AWG 16	1.75 mm	8 mm																							
2.5 mm² AWG 14	2.25 mm	6 mm																							
<p>Han D®, Crimp contact, silver plated contacts, contact resistance ≤3 mOhm</p> 	0.14–0.37 0.5 0.75 1 1.5 2.5	09 15 000 6104 09 15 000 6103 09 15 000 6105 09 15 000 6102 09 15 000 6101 09 15 000 6106	09 15 000 6204 09 15 000 6203 09 15 000 6205 09 15 000 6202 09 15 000 6201 09 15 000 6206	 <table border="1"> <thead> <tr> <th>Wire gauge</th> <th>∅</th> <th>Stripping length</th> </tr> </thead> <tbody> <tr> <td>0.14-0.37 mm² AWG 26-22</td> <td>0.9 mm</td> <td>8 mm</td> </tr> <tr> <td>0.5 mm² AWG 20</td> <td>1.1 mm</td> <td>8 mm</td> </tr> <tr> <td>0.75 mm² AWG 18</td> <td>1.3 mm</td> <td>8 mm</td> </tr> <tr> <td>1 mm² AWG 18</td> <td>1.45 mm</td> <td>8 mm</td> </tr> <tr> <td>1.5 mm² AWG 16</td> <td>1.75 mm</td> <td>8 mm</td> </tr> <tr> <td>2.5 mm² AWG 14</td> <td>2.25 mm</td> <td>6 mm</td> </tr> </tbody> </table>	Wire gauge	∅	Stripping length	0.14-0.37 mm² AWG 26-22	0.9 mm	8 mm	0.5 mm² AWG 20	1.1 mm	8 mm	0.75 mm² AWG 18	1.3 mm	8 mm	1 mm² AWG 18	1.45 mm	8 mm	1.5 mm² AWG 16	1.75 mm	8 mm	2.5 mm² AWG 14	2.25 mm	6 mm
Wire gauge	∅	Stripping length																							
0.14-0.37 mm² AWG 26-22	0.9 mm	8 mm																							
0.5 mm² AWG 20	1.1 mm	8 mm																							
0.75 mm² AWG 18	1.3 mm	8 mm																							
1 mm² AWG 18	1.45 mm	8 mm																							
1.5 mm² AWG 16	1.75 mm	8 mm																							
2.5 mm² AWG 14	2.25 mm	6 mm																							

Han® K 6/36

Size 16 B

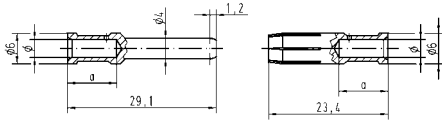

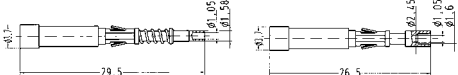
Identification	Wire cross section (mm ²)	Part number		Drawing Dimensions in mm																		
		male	female																			
Han® C, Crimp contact, silver plated contacts, contact resistance ≤1 mOhm 	1.5	09 32 000 6104	09 32 000 6204	 <table border="1" data-bbox="1038 499 1497 636"> <thead> <tr> <th>Wire gauge</th> <th>∅</th> <th>Stripping length</th> </tr> </thead> <tbody> <tr> <td>1.5 mm² AWG 16</td> <td>1.75</td> <td>9.5 mm</td> </tr> <tr> <td>2.5 mm² AWG 14</td> <td>2.25</td> <td>9.5 mm</td> </tr> <tr> <td>4 mm² AWG 12</td> <td>2.85</td> <td>9.5 mm</td> </tr> <tr> <td>6 mm² AWG 10</td> <td>3.5</td> <td>9.5 mm</td> </tr> <tr> <td>10 mm² AWG 8</td> <td>4.3</td> <td>12 mm</td> </tr> </tbody> </table>	Wire gauge	∅	Stripping length	1.5 mm ² AWG 16	1.75	9.5 mm	2.5 mm ² AWG 14	2.25	9.5 mm	4 mm ² AWG 12	2.85	9.5 mm	6 mm ² AWG 10	3.5	9.5 mm	10 mm ² AWG 8	4.3	12 mm
	Wire gauge	∅	Stripping length																			
	1.5 mm ² AWG 16	1.75	9.5 mm																			
	2.5 mm ² AWG 14	2.25	9.5 mm																			
4 mm ² AWG 12	2.85	9.5 mm																				
6 mm ² AWG 10	3.5	9.5 mm																				
10 mm ² AWG 8	4.3	12 mm																				
2.5	09 32 000 6105	09 32 000 6205																				
4	09 32 000 6107	09 32 000 6207																				
6	09 32 000 6108	09 32 000 6208																				
F.O. contact  for 1 mm plastic fibre		20 10 001 3211	20 10 001 3221	 20 10 001 3211 + 20 10 001 3221																		

Han-Com

Han® K 12/2



Features

- Combination of power and signal area in one connector
- Crimp termination for power and signal area
- Use of standard Han® C and Han D® contacts

Derating

Current carrying capacity

The current carrying capacity of the connectors is limited by the thermal load capability of the contact element material including the connections and the insulating parts. The derating curve is therefore valid for currents which flow constantly (non-intermittent) through each contact element of the connector evenly, without exceeding the allowed maximum temperature.

Measuring and testing techniques acc. to IEC 60512-5-2

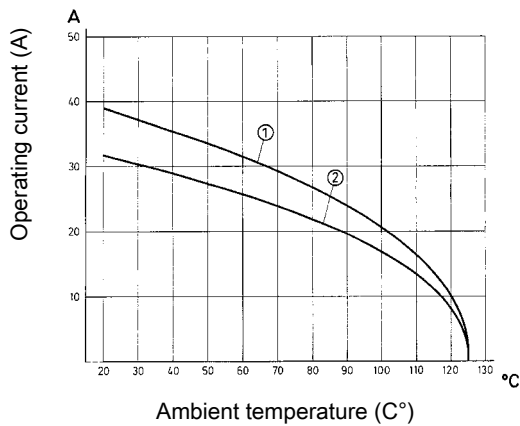

- ① Wire cross section 6 mm²
- ② Wire cross section 4 mm²

Technical characteristics

Contacts	12/2
Electrical data acc. to IEC 61984	40 A 690 V 8 kV 3
Rated current	40 A
Rated voltage	690 V
Rated impulse voltage	8 kV
Pollution degree	3
Electrical data, signal	10 A 250 V 4 kV 3
Rated current	10 A
Rated voltage	250 V
Rated impulse voltage	4 kV
Rated voltage acc. to UL	600 V
Rated voltage acc. to UL, signal	600 V
Rated voltage acc. to CSA	300 V
Rated voltage acc. to CSA, signal	300 V
Insulation resistance	≥10 ¹⁰ Ohm
Limiting temperatures	-40 °C ... 125 °C
Flammability (insert) acc. to UL 94	V 0
Mating cycles	≥500
Material (insert)	polycarbonate
Colour (insert)	RAL 7032 (light grey)
Material (contact)	copper alloy
Material (contact, signal area)	copper alloy

Specifications and approvals

IEC 60664-1
IEC 61984



Details

Hoods/Housings see chapter 31

Crimping tools see chapter 90

Remarks on the crimp technique

The wire gauges mentioned in the catalogue refer to geometric wire gauges of cables.

Han-Com

Han® K 12/2





Size 16 B

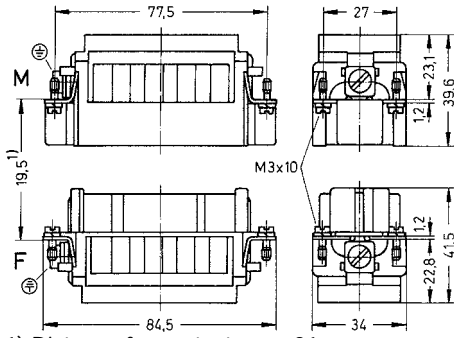
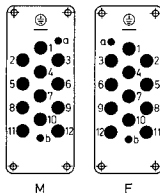

Number of contacts

12/2+

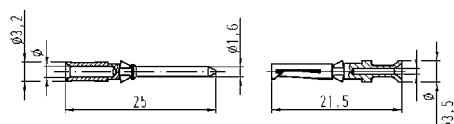
690 V / 250 V
40 A/10 A

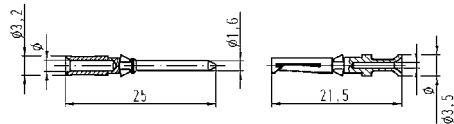

Identification	Wire cross section (mm²)	Part number		Drawing Dimensions in mm																					
		male	female																						
<p>Han-Com®, Crimp/crimp terminal</p>  <p>Please order crimp contacts separately.</p>		09 32 012 3001	09 32 012 3101	 <p>1) Distance for contact max. 21 mm Max. insulation diameter 5 mm</p>  <p>Contact arrangement (view from termination side)</p>																					
<p>Han D®, Crimp contact, gold plated contacts, contact resistance ≤3 mOhm</p> 	0.14–0.37 0.5 0.75 1 1.5 2.5	09 15 000 6124 09 15 000 6123 09 15 000 6125 09 15 000 6122 09 15 000 6121 09 15 000 6126	09 15 000 6224 09 15 000 6223 09 15 000 6225 09 15 000 6222 09 15 000 6221 09 15 000 6226	 <table border="1"> <thead> <tr> <th>Wire gauge</th> <th>∅</th> <th>Stripping length</th> </tr> </thead> <tbody> <tr> <td>0.14-0.37 mm² AWG 26-22</td> <td>0.9 mm</td> <td>8 mm</td> </tr> <tr> <td>0.5 mm² AWG 20</td> <td>1.1 mm</td> <td>8 mm</td> </tr> <tr> <td>0.75 mm² AWG 18</td> <td>1.3 mm</td> <td>8 mm</td> </tr> <tr> <td>1 mm² AWG 18</td> <td>1.45 mm</td> <td>8 mm</td> </tr> <tr> <td>1.5 mm² AWG 16</td> <td>1.75 mm</td> <td>8 mm</td> </tr> <tr> <td>2.5 mm² AWG 14</td> <td>2.25 mm</td> <td>6 mm</td> </tr> </tbody> </table>	Wire gauge	∅	Stripping length	0.14-0.37 mm² AWG 26-22	0.9 mm	8 mm	0.5 mm² AWG 20	1.1 mm	8 mm	0.75 mm² AWG 18	1.3 mm	8 mm	1 mm² AWG 18	1.45 mm	8 mm	1.5 mm² AWG 16	1.75 mm	8 mm	2.5 mm² AWG 14	2.25 mm	6 mm
Wire gauge	∅	Stripping length																							
0.14-0.37 mm² AWG 26-22	0.9 mm	8 mm																							
0.5 mm² AWG 20	1.1 mm	8 mm																							
0.75 mm² AWG 18	1.3 mm	8 mm																							
1 mm² AWG 18	1.45 mm	8 mm																							
1.5 mm² AWG 16	1.75 mm	8 mm																							
2.5 mm² AWG 14	2.25 mm	6 mm																							
<p>Han D®, Crimp contact, silver plated contacts, contact resistance ≤3 mOhm</p> 	0.14–0.37 0.5 0.75 1 1.5 2.5	09 15 000 6104 09 15 000 6103 09 15 000 6105 09 15 000 6102 09 15 000 6101 09 15 000 6106	09 15 000 6204 09 15 000 6203 09 15 000 6205 09 15 000 6202 09 15 000 6201 09 15 000 6206	 <table border="1"> <thead> <tr> <th>Wire gauge</th> <th>∅</th> <th>Stripping length</th> </tr> </thead> <tbody> <tr> <td>0.14-0.37 mm² AWG 26-22</td> <td>0.9 mm</td> <td>8 mm</td> </tr> <tr> <td>0.5 mm² AWG 20</td> <td>1.1 mm</td> <td>8 mm</td> </tr> <tr> <td>0.75 mm² AWG 18</td> <td>1.3 mm</td> <td>8 mm</td> </tr> <tr> <td>1 mm² AWG 18</td> <td>1.45 mm</td> <td>8 mm</td> </tr> <tr> <td>1.5 mm² AWG 16</td> <td>1.75 mm</td> <td>8 mm</td> </tr> <tr> <td>2.5 mm² AWG 14</td> <td>2.25 mm</td> <td>6 mm</td> </tr> </tbody> </table>	Wire gauge	∅	Stripping length	0.14-0.37 mm² AWG 26-22	0.9 mm	8 mm	0.5 mm² AWG 20	1.1 mm	8 mm	0.75 mm² AWG 18	1.3 mm	8 mm	1 mm² AWG 18	1.45 mm	8 mm	1.5 mm² AWG 16	1.75 mm	8 mm	2.5 mm² AWG 14	2.25 mm	6 mm
Wire gauge	∅	Stripping length																							
0.14-0.37 mm² AWG 26-22	0.9 mm	8 mm																							
0.5 mm² AWG 20	1.1 mm	8 mm																							
0.75 mm² AWG 18	1.3 mm	8 mm																							
1 mm² AWG 18	1.45 mm	8 mm																							
1.5 mm² AWG 16	1.75 mm	8 mm																							
2.5 mm² AWG 14	2.25 mm	6 mm																							

Han-Com

Han® K 12/2

Size 16 B

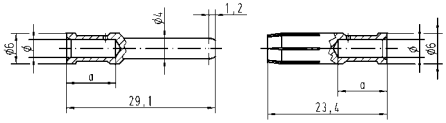

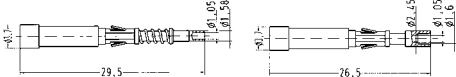
Identification	Wire cross section (mm ²)	Part number		Drawing Dimensions in mm																		
		male	female																			
Han® C, Crimp contact, silver plated contacts, contact resistance ≤1 mOhm 	1.5	09 32 000 6104	09 32 000 6204	 <table border="1" data-bbox="1008 501 1465 636"> <thead> <tr> <th>Wire gauge</th> <th>∅</th> <th>Stripping length</th> </tr> </thead> <tbody> <tr> <td>1.5 mm² AWG 16</td> <td>1.75</td> <td>9.5 mm</td> </tr> <tr> <td>2.5 mm² AWG 14</td> <td>2.25</td> <td>9.5 mm</td> </tr> <tr> <td>4 mm² AWG 12</td> <td>2.85</td> <td>9.5 mm</td> </tr> <tr> <td>6 mm² AWG 10</td> <td>3.5</td> <td>9.5 mm</td> </tr> <tr> <td>10 mm² AWG 8</td> <td>4.3</td> <td>12 mm</td> </tr> </tbody> </table>	Wire gauge	∅	Stripping length	1.5 mm ² AWG 16	1.75	9.5 mm	2.5 mm ² AWG 14	2.25	9.5 mm	4 mm ² AWG 12	2.85	9.5 mm	6 mm ² AWG 10	3.5	9.5 mm	10 mm ² AWG 8	4.3	12 mm
	Wire gauge	∅	Stripping length																			
	1.5 mm ² AWG 16	1.75	9.5 mm																			
	2.5 mm ² AWG 14	2.25	9.5 mm																			
4 mm ² AWG 12	2.85	9.5 mm																				
6 mm ² AWG 10	3.5	9.5 mm																				
10 mm ² AWG 8	4.3	12 mm																				
2.5	09 32 000 6105	09 32 000 6205																				
4	09 32 000 6107	09 32 000 6207																				
6	09 32 000 6108	09 32 000 6208																				
F.O. contact  for 1 mm plastic fibre		20 10 001 3211	20 10 001 3221	 20 10 001 3211 + 20 10 001 3221																		

Han-Com

Han[®] K 4/8



Features

- Combination of power and signal area in one connector
- Screw termination for power and signal area

Derating

Current carrying capacity

The current carrying capacity of the connectors is limited by the thermal load capability of the contact element material including the connections and the insulating parts. The derating curve is therefore valid for currents which flow constantly (non-intermittent) through each contact element of the connector evenly, without exceeding the allowed maximum temperature.

Measuring and testing techniques acc. to IEC 60512-5-2

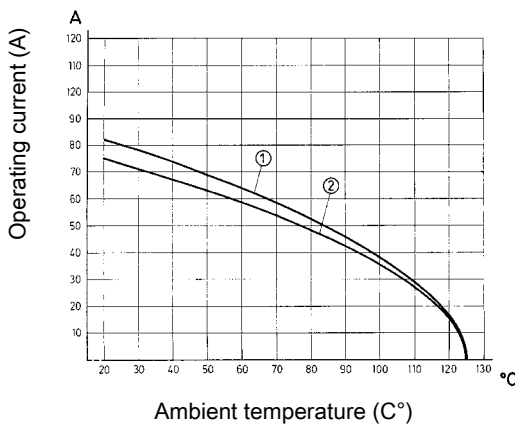

- ① Wire cross section 16 mm²
- ② Wire cross section 10 mm²

Technical characteristics

Contacts	4/8
Electrical data acc. to IEC 61984	80 A 400 V 6 kV 3
Rated current	80 A
Rated voltage	400 V
Rated impulse voltage	6 kV
Pollution degree	3
Electrical data, signal	16 A 400 V 6 kV 3
Rated current	16 A
Rated voltage	400 V
Rated impulse voltage	6 kV
Rated voltage acc. to UL	600 V
Rated voltage acc. to UL, signal	600 V
Rated voltage acc. to CSA	600 V
Rated voltage acc. to CSA, signal	600 V
Insulation resistance	≥10 ¹⁰ Ohm
Limiting temperatures	-40 °C ... 125 °C
Flammability (insert) acc. to UL 94	HB
Mating cycles	≥500
Material (insert)	polyamide
Colour (insert)	RAL 7032 (light grey)
Material (contact)	copper alloy
Material (contact, signal area)	copper alloy

Specifications and approvals

IEC 60664-1
IEC 61984



Details

Hoods/Housings see chapter 31

In accordance with the appropriate regulations a wire-end sleeve has to be used at clamps without wire protection (see "screw terminal", chapter 00).

Han-Com

Han® K 4/8

Size 24 B



Number of contacts

4/8+

400 V / 400 V
80 A/16 A

Han-Com

Han-Com®,
Screw terminal / Screw terminal,
silver plated contacts,
contact resistance ≤ 0.3 mOhm
contact resistance, signal ≤ 1 mOhm

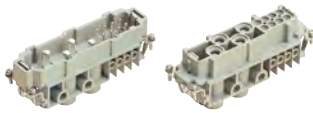

Wire cross section (mm²)

1.5 – 16

Part number

male

female

09 38 012 2601

09 38 012 2701

Drawing
Dimensions in mm

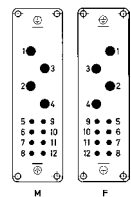
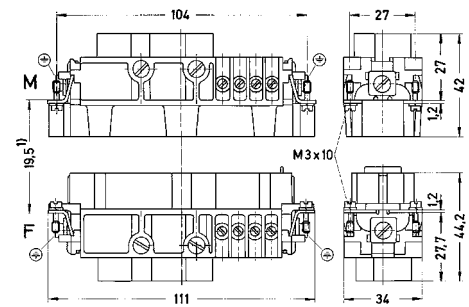

Contact arrangement (view from termination side)

power contacts		
wire gauge	tightening torque	stripping length
1.5 mm ²	1.2 Nm	14 mm
2.5 mm ²	2 Nm	14 mm
4 mm ²	3 Nm	14 mm
6 mm ²	3 Nm	14 mm
10 mm ²	3 Nm	14 mm
16 mm ²	3 Nm	14 mm

Signal contacts :
Wire cross section 0.5 ... 2.5 mm²
Stripping length 7.5 mm

Han® K 6/6



Features

- Combination of power and signal area in one connector
- Axial screw termination for power area
- Screw termination for signal area

Derating

Current carrying capacity

The current carrying capacity of the connectors is limited by the thermal load capability of the contact element material including the connections and the insulating parts. The derating curve is therefore valid for currents which flow constantly (non-intermittent) through each contact element of the connector evenly, without exceeding the allowed maximum temperature.

Measuring and testing techniques acc. to IEC 60512-5-2

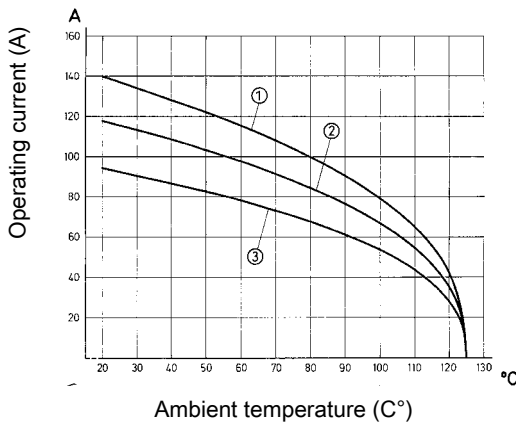

- ① Wire cross section 35 mm²
- ② Wire cross section 25 mm²
- ③ Wire cross section 16 mm²

Technical characteristics

Contacts	6/6
Electrical data acc. to IEC 61984	100 A 690 V 8 kV 3
Rated current	100 A
Rated voltage	690 V
Rated impulse voltage	8 kV
Pollution degree	3
Electrical data, signal	16 A 400 V 6 kV 3
Rated current	16 A
Rated voltage	400 V
Rated impulse voltage	6 kV
Rated current acc. to CSA	100 A
Rated current acc. to CSA, signal area	15 A
Rated voltage acc. to UL	600 V
Rated voltage acc. to UL, signal	300 V
Rated voltage acc. to CSA	600 V
Rated voltage acc. to CSA, signal	600 V
Insulation resistance	≥10 ¹⁰ Ohm
Limiting temperatures	-40 °C ... 125 °C
Flammability (insert) acc. to UL 94	V 0
Mating cycles	≥500
Material (insert)	polycarbonate
Colour (insert)	RAL 7032 (light grey)
Material (contact)	copper alloy
Material (contact, signal area)	copper alloy
Hex key	SW 4

Han-Com

Specifications and approvals

IEC 60664-1
IEC 61984



Details

Hoods/Housings see chapter 31

Hex key with grip 09 99 000 0363 see chapter 90

Adapter 3/8" 09 99 000 0370 see chapter 90

Remarks on the axial screw technique

The wire gauges mentioned in the catalogue refer to geometric wire gauges of cables.

Han® K 6/6

Size 24 B



Number of contacts

6/6+



690 V / 400 V
100 A/16 A

Han-Com

Han-Com®, Axial screw terminal / Screw terminal, silver plated contacts, contact resistance ≤0.5 mOhm contact resistance, signal ≤3 mOhm



Identification	Wire cross section (mm²)	Part number	
		male	female
Han-Com®, Axial screw terminal / Screw terminal, silver plated contacts, contact resistance ≤0.5 mOhm contact resistance, signal ≤3 mOhm	16 – 35	09 38 012 2651	09 38 012 2751

Drawing Dimensions in mm

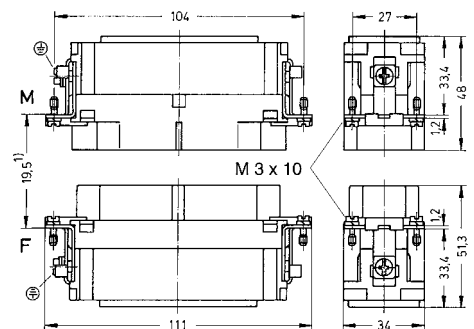

1) Distance for contact max. 21 mm

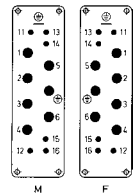

Contact arrangement (view from termination side)

power contacts			
wire gauge	tightening torque	stripping length	max. insulation diameter
10 mm²	6 Nm	13 ... 14 mm	11.4 mm
25 mm²	7 Nm	13 ... 14 mm	11.4 mm
35 mm²	8 Nm	13 ... 14 mm	11.4 mm

Signal contacts :
Wire cross section 0.2 ... 2.5 mm²
Stripping length 7.5 mm

Han® K 8/0



Features

- Axial screw termination for power area
- No signal contacts

Derating

Current carrying capacity

The current carrying capacity of the connectors is limited by the thermal load capability of the contact element material including the connections and the insulating parts. The derating curve is therefore valid for currents which flow constantly (non-intermittent) through each contact element of the connector evenly, without exceeding the allowed maximum temperature.

Measuring and testing techniques acc. to IEC 60512-5-2

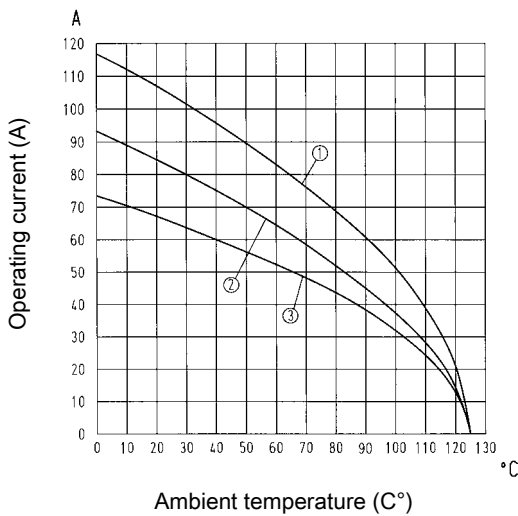

- ① Wire cross section 25 mm²
- ② Wire cross section 16 mm²
- ③ Wire cross section 10 mm²

Technical characteristics

Contacts	8/0
Electrical data acc. to IEC 61984	100 A 690 V 8 kV 3
Rated current	100 A
Rated voltage	690 V
Rated impulse voltage	8 kV
Pollution degree	3
Rated current acc. to UL	82 A
Rated voltage acc. to UL	600 V
Insulation resistance	≥10 ¹⁰ Ohm
Limiting temperatures	-40 °C ... 125 °C
Flammability (insert) acc. to UL 94	V 0
Mating cycles	≥500
Material (insert)	polycarbonate
Colour (insert)	RAL 7032 (light grey)
Material (contact)	copper alloy
Hex key	SW 4

Specifications and approvals

IEC 60664-1
IEC 61984



Details

Hoods/Housings see chapter 31

Hex key with grip 09 99 000 0363 see chapter 90

Adapter 3/8" 09 99 000 0370 see chapter 90

Remarks on the axial screw technique

The wire gauges mentioned in the catalogue refer to geometric wire gauges of cables.

Han-Com

Han® K 8/0

Size 24 B



Number of contacts

8/0+

690 V
100 A

Han-Com

Han-Com®, Axial screw terminal, silver plated contacts, contact resistance ≤0.5 mOhm



Wire cross section (mm²)

10 – 25

Part number

male

female

09 38 008 2653

09 38 008 2753

Drawing Dimensions in mm

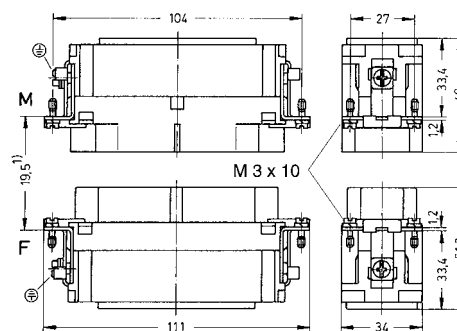

1) Distance for contact max. 21 mm

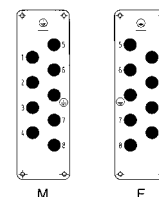

Contact arrangement (view from termination side)

power contacts			
wire gauge	tightening torque	stripping length	max. insulation diameter
10 mm²	6 Nm	13 ... 14 mm	11.4 mm
16 mm²	7 Nm	13 ... 14 mm	11.4 mm
25 mm²	7 Nm	13 ... 14 mm	11.4 mm