

MATERIALS AND FINISH:

SHELL: STEEL MATERIAL, NICKEL FINISH
 INSULATOR: (SEE CHART) = 260°C, UL 94V-0 RATED, BLACK
 CONTACT MATERIAL: COPPER ALLOY
 CONTACT FINISH: SELECT GOLD PLATING

ELECTRICAL:

CONTACT CURRENT RATING: 5 AMPS
 CONTACT RESISTANCE: 10 Milliohms Max.
 DIELECTRIC WITHSTANDING VOLTAGE: 1,000VAC Min.
 INSULATION RESISTANCE: 5 GOHMS Min.
 TEMPERATURE RATING: -55° ~ +125° C

180-MYY-1XYRYYY

SERIES _____
 MACHINED CONTACTS _____
 POSITIONS _____
 015 _____
 026 _____
 044 _____
 062 _____
 GENDER _____
 1 = MALE
 X = CONTACT LENGTH _____
 1 = 0.256"
 A = 0.140"
 SHELL PLATING _____
 3 = NICKEL (GROUND INDENTS)
 RoHS COMPLIANT (260°C) _____
 HARDWARE OPTIONS _____
 00 = NO HARDWARE, Ø.120" HOLE
 01 = .098" CLINCH NUT (BOARD SIDE)
 02 = .250" CLINCH NUT (BOARD SIDE)
 03 = .250" CLINCH NUT (MATING SIDE)
 05 = .224" 4-40 BOARD LOCK
 08 = .228" BOARD LOCK, BOARD SIDE
 90 = .224" 4-40 BOARD LOCK
 FOR 0.093" BOARD MAX.
 91 = .224" 4-40 SPACER/BOARD LOCK
 92 = .224" 4-40 SPACER/BOARD LOCK
 FOR 0.093" BOARD MAX.
 PLATING OPTIONS _____
 1 = GOLD FLASH, ENTIRE CONTACT
 2 = 30u" GOLD, ENTIRE CONTACT

DIMENSIONS (IN.)

No. OF PINS	A	B	C	D	INSULATOR MATERIAL
15	0.665	0.984	1.213	0.090	PA9T
	16.90	25.00	30.80	2.29	
26	0.994	1.311	1.543	0.090	PA9T
	25.25	33.30	39.20	2.29	
44	1.534	1.852	2.089	0.090	PA9T
	38.95	47.05	53.05	2.29	
62	2.181	2.500	2.732	0.095	PA6T
	55.40	63.50	69.40	2.41	

DO NOT SCALE FROM DRAWING

	THESE DRAWINGS AND SPECIFICATIONS ARE THE PROPERTY OF NorComp AND SHALL NOT BE REPRODUCED, COPIED OR USED AS THE BASIS FOR THE MANUFACTURE OF SALE OF APPARATUS WITHOUT WRITTEN PERMISSION.		DRAWN: C. SMITH	DATE: 03-16-07
			CHECKED:	DATE:
NorComp		SCALE: 1 : 1	SHEET 1 OF 3	REV 11
		DWG NO. 180-MYY-11YRYYY		

RoHS COMPLIANT

ALL CLINCH-NUTS ARE 4-40 INTERNAL THREADS

TOLERANCE:
ALL DIMENSIONS ARE ±0.010

01X 0.098" (BOARD SIDE) - CN1

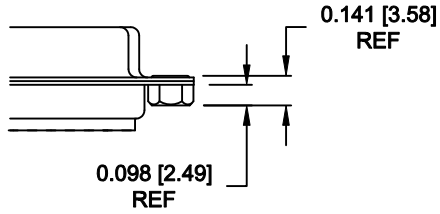

02X 0.250" (BOARD SIDE) - CN2

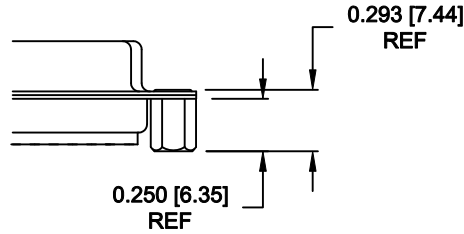

03X..... 0.250" (MATING SIDE) - CN8

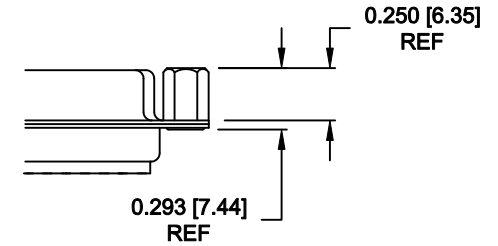

05X 0.224" BOARD SIDE - CN10

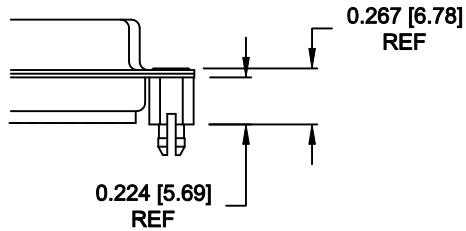

08X 0.228" BOARD SIDE - CN10

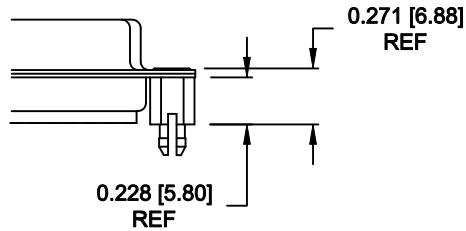

91X 0.224" BOARD SIDE
0.189 MATING SIDE
CN10/SFSO4404

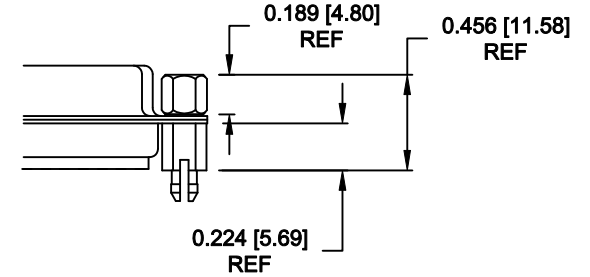

NOTE: 4-40 FEMALE SCREW LOCK IS REMOVABLE

90X 0.224" BOARD SIDE - CN10

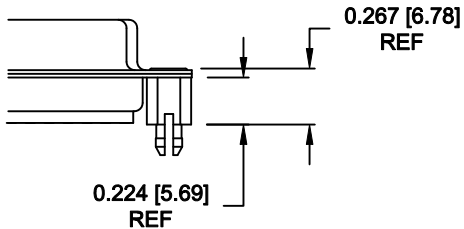

92X 0.224" BOARD SIDE
0.189 MATING SIDE
CN10/SFSO4404

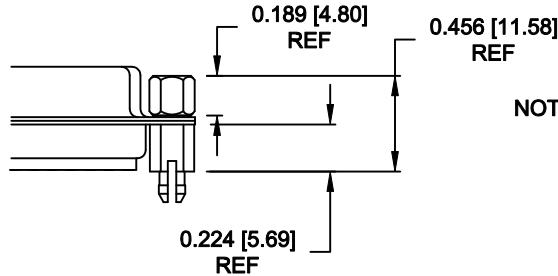

NOTE: 4-40 FEMALE SCREW LOCK IS REMOVABLE

DO NOT SCALE FROM DRAWING

NOTE: 90 & 92 OPTION FOR 0.093" MAX. BOARD THICKNESS

RoHS COMPLIANT

	THESE DRAWINGS AND SPECIFICATIONS ARE THE PROPERTY OF NorComp AND SHALL NOT BE REPRODUCED, COPIED OR USED AS THE BASIS FOR THE MANUFACTURE OF SALE OF APPARATUS WITHOUT WRITTEN PERMISSION.		DRAWN: C. SMITH	DATE: 02-12-08
			CHECKED:	DATE:
NorComp			SCALE:	SHEET 2 OF 3
			DWG NO. 180-MYY-11YRYYY	

DESCRIPTION: LAYOUT - HIGH DENSITY - MACHINED CONTACTS - VERTICAL

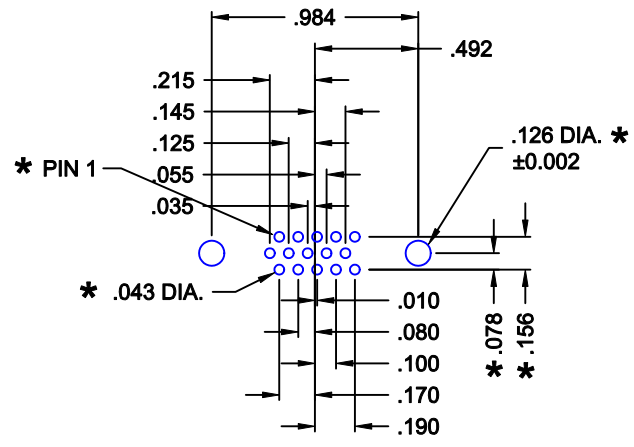

15 POSITION

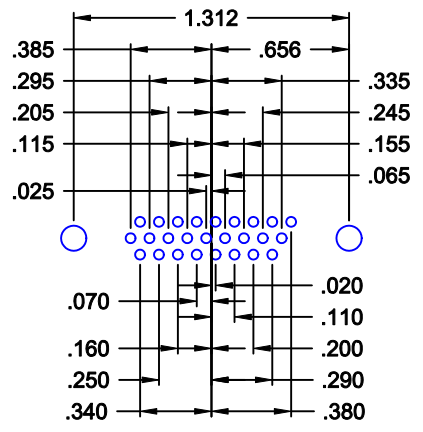

26 POSITION

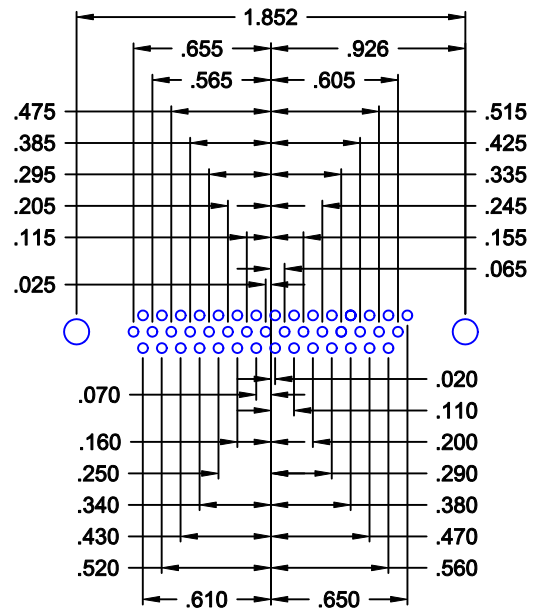

44 POSITION

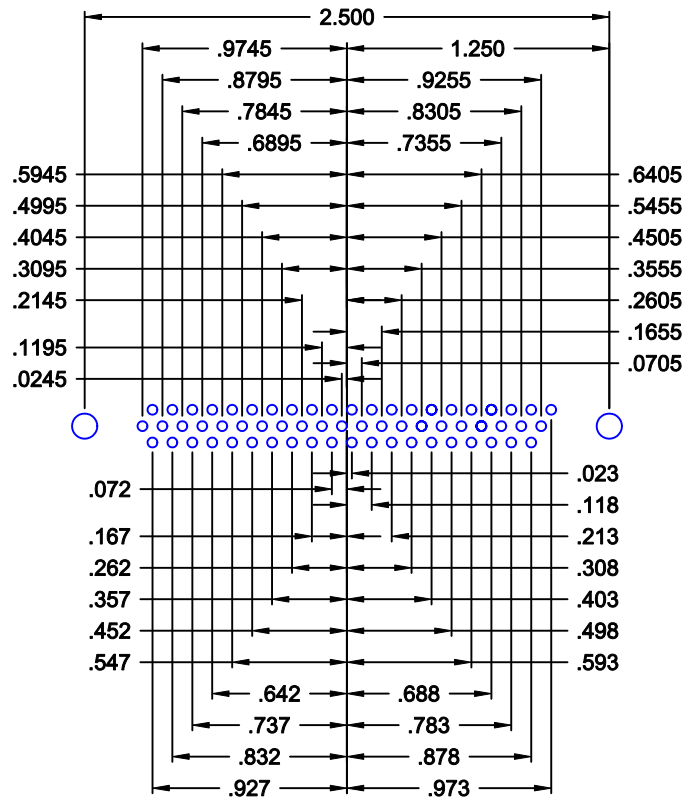

62 POSITION

* TYP. ON ALL SIZES

DO NOT SCALE FROM DRAWING

	THESE DRAWINGS AND SPECIFICATIONS ARE THE PROPERTY OF NorComp AND SHALL NOT BE REPRODUCED, COPIED OR USED AS THE BASIS FOR THE MANUFACTURE OF SALE OF APPARATUS WITHOUT WRITTEN PERMISSION.		DRAWN: C. SMITH	DATE: 03-16-07
			CHECKED:	DATE:
NorComp		SCALE: 1 : 1	SHEET 3 OF 3	REV 11
		DWG NO. 180-MYY-11YRYYY		