

DESCRIPTION: M12 FEMALE - RIGHT ANGLE - 5 POS.

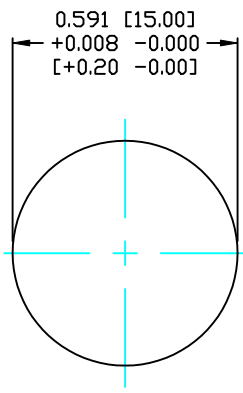

PANEL CUTOUT

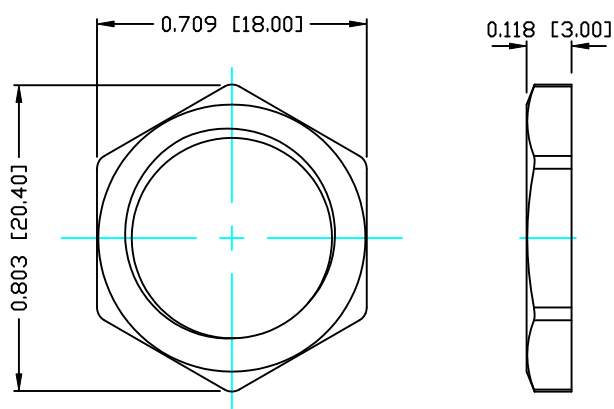

NUT

NOTE:

MATERIAL	
HOUSING:	PBT UL94V-0, BLACK
CONTACT:	BRASS
NUT:	BRASS
O-RING:	NBR, BLACK
BACK HOUSING:	PBT, UL94V-0, BLACK
DOWN HOUSING:	PBT, UL94V-0, BLACK
FINISH	
CONTACT:	GOLD PLATED
UNDER PLATE:	NICKEL
SHELL:	STAIN NICKEL (80-100µ) OVER ALL
ELECTRICAL	
RATED CURRENT:	5A
RATED VOLTAGE:	125V
WATER PROOF:	IP67
ENVIRONMENT	
OPERATION TEMPERATURE:	-40°C TO +85°C

861-005-213R00Y

1 = GOLD FLASH
4 = 10µ" GOLD

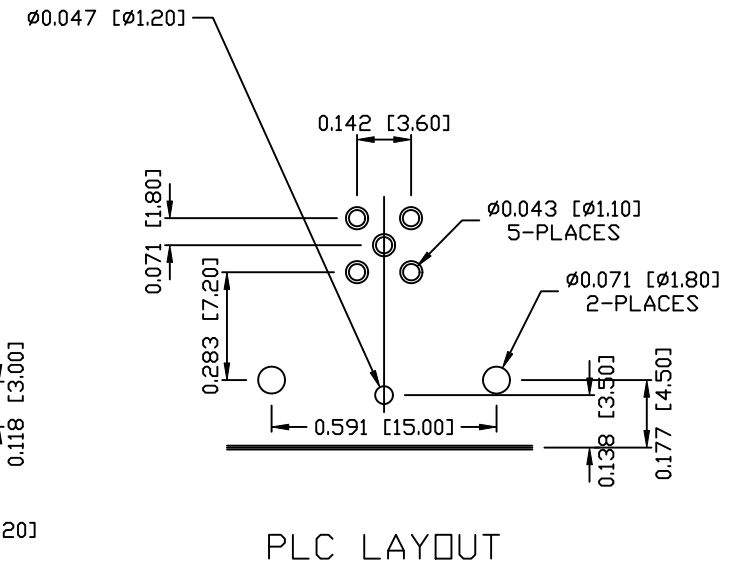
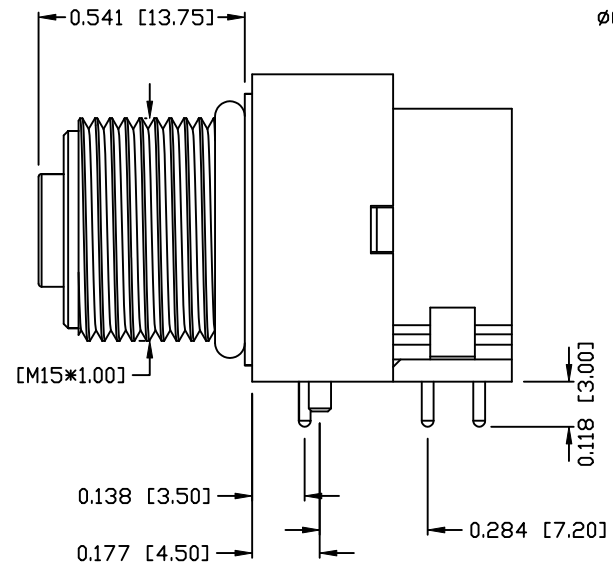
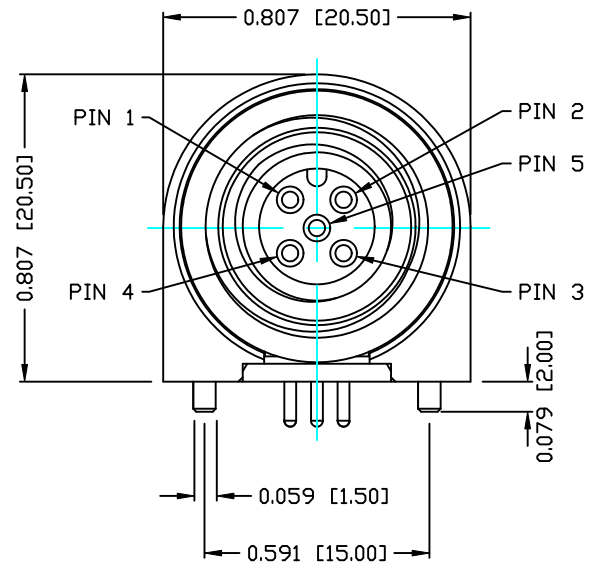

PLC LAYOUT

RoHS COMPLIANT

DO NOT SCALE FROM DRAWING



THESE DRAWINGS AND SPECIFICATIONS ARE THE PROPERTY OF NorComp AND SHALL NOT BE REPRODUCED, COPIED OR USED AS THE BASIS FOR THE MANUFACTURE OR SALE OF APPARATUS WITHOUT WRITTEN PERMISSION.

DRAWN:	M. SIGMON	DATE:	03-07-16
CHECKED:		DATE:	

NorComp

SCALE:	N.T.S.	SHEET	1	OF	1	REV	0
DWG NO.	861-005-213R00Y						