

Mating Angle Illustration
Scale 2:1

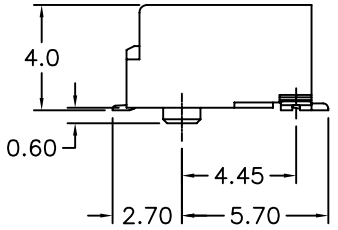

Series **8402-67G00** x **5** T
 No. of Pin Count
 G: Gold Plated
 00: G/F
 T: Tape & Reel Package
 5: 4.0mm Height
 A: Key A
 B: Key B
 E: Key E
 M: Key M

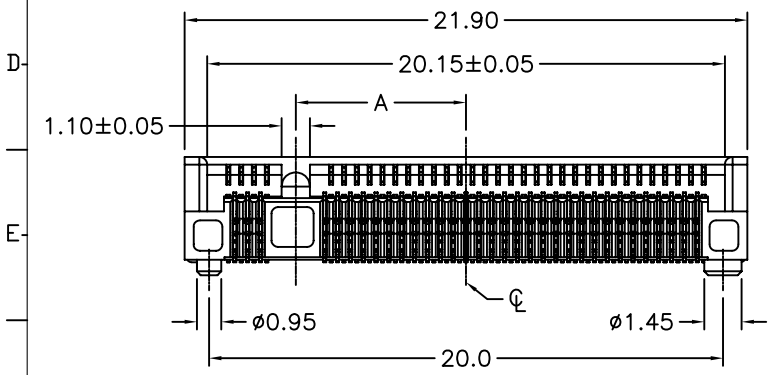
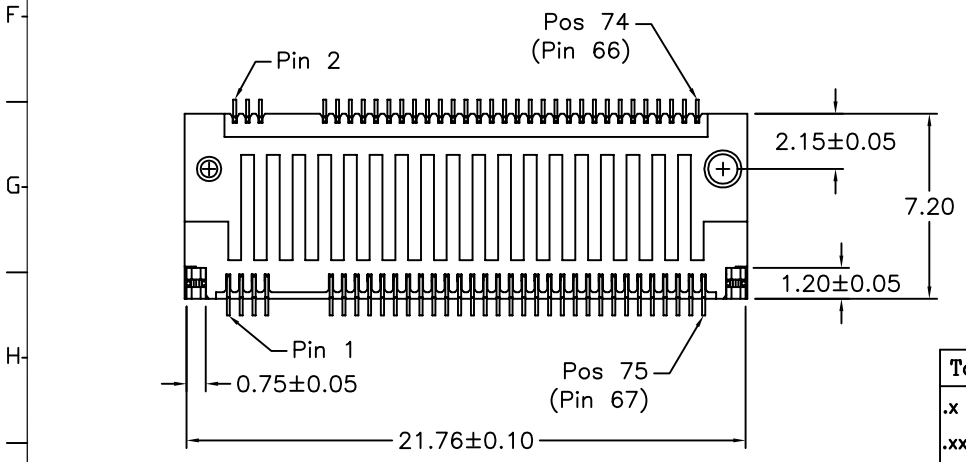

Key	Dimension							
	A	B	C	D	E	F	G	Pad Removed
A	6.625	1.5	14.5	1.0	14.5	1.375	1.125	Pos 8~15
B	5.625	2.5	13.5	2.0	13.5	1.375	1.125	Pos 12~19
E	2.625	5.5	10.5	5.0	10.5	1.375	1.125	Pos 24~31
M	-6.125	14.0	2.0	14.0	1.5	1.125	1.375	Pos 59~66

Tolerances	Dwg. No.	8402D01005		Title:	
.x = ±0.25	Projection			8402 Series NGFF	
.xx = ±0.15	Unit	mm	Scale		1:1
.xxx = ±0.05	Drawn By	Vic Lyu10/15'15			

① 661

OUPIN			
OUPIN ELECTRONIC(KUNSHAN) CO., LTD.			
P/N: 8402-67G00x5T			
SHEET	1/2	Ver. No.	A2

REV.	SPECIFICATION	ECN NO.	APPD.

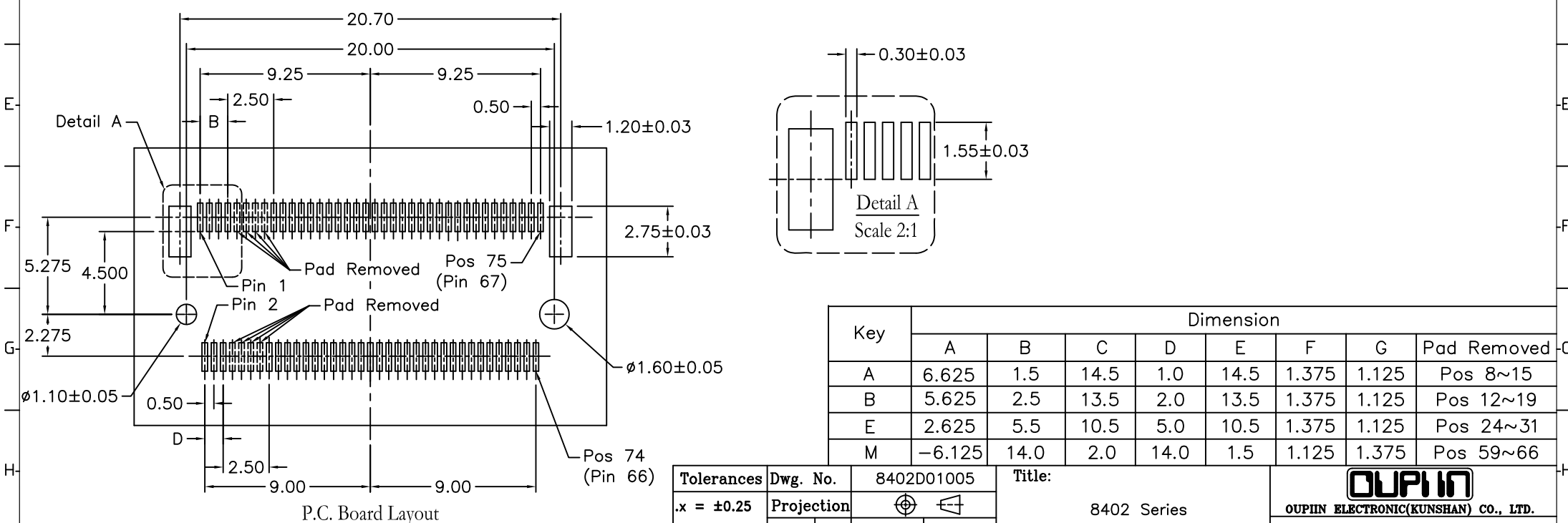
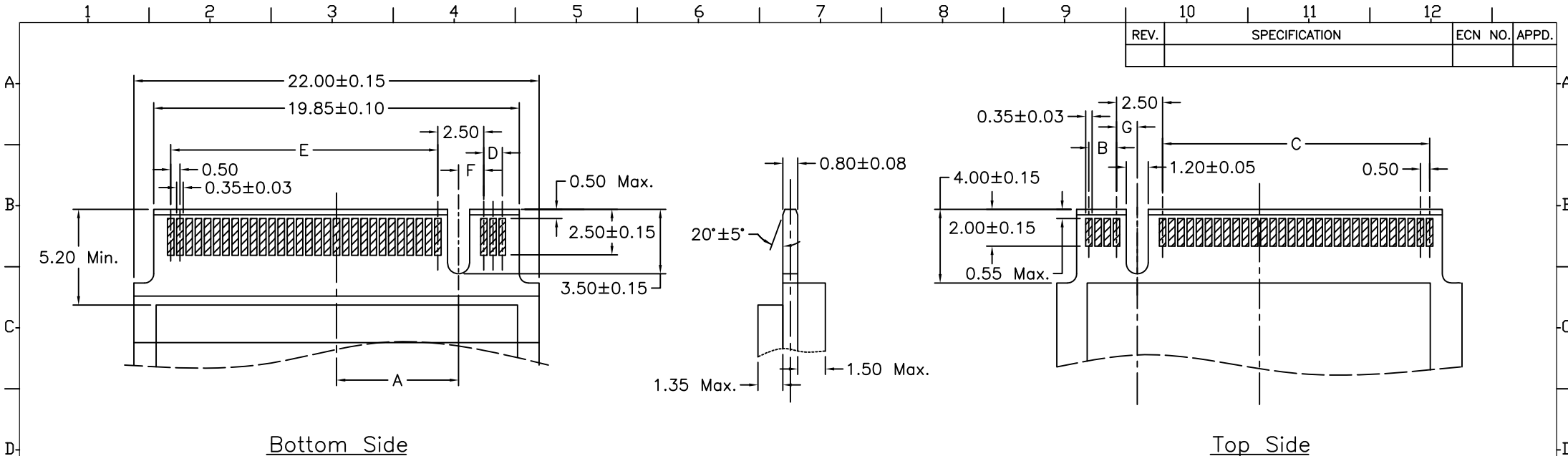

Key	Dimension							
	A	B	C	D	E	F	G	Pad Removed
A	6.625	1.5	14.5	1.0	14.5	1.375	1.125	Pos 8~15
B	5.625	2.5	13.5	2.0	13.5	1.375	1.125	Pos 12~19
E	2.625	5.5	10.5	5.0	10.5	1.375	1.125	Pos 24~31
M	-6.125	14.0	2.0	14.0	1.5	1.125	1.375	Pos 59~66

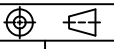
Tolerances	Dwg. No.	8402D01005		Title:		 OUPIIN ELECTRONIC(KUNSHAN) CO., LTD. P/N: 8402-67G00x5T SHEET 2/2 Ver. No. A2			
.x = ±0.25	Projection			8402 Series					
.xx = ±0.15	Unit	mm	Scale	NGFF					
.xxx = ±0.05	Drawn By	Vic Lyu10/15'15		661					