

8971 Series

Micro USB SMD Type

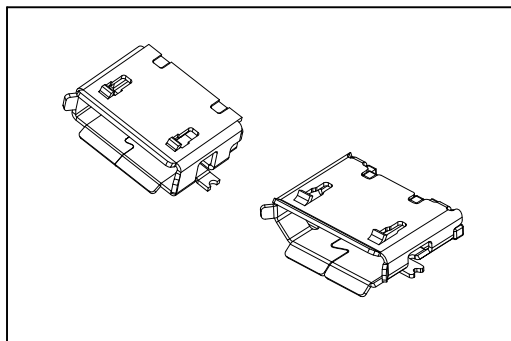

Material:

Housing: High Temperature Plastic UL94V-0.

Contacts: Copper Alloy.

Shell: Copper Alloy.

Electrical Characteristics:

Current Rating: 1.0 A.

Dielectric Withstanding Voltage: AC 100V.

Insulator Resistance: 100MΩ min.

Contact Resistance: 50mΩ max.

Operating Temperature: -30°C~ +80°C.

AB Type

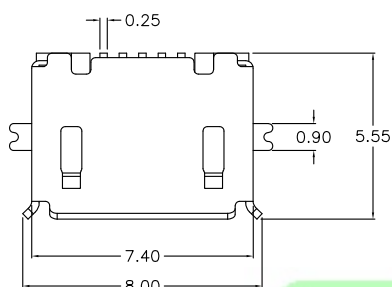

B Type

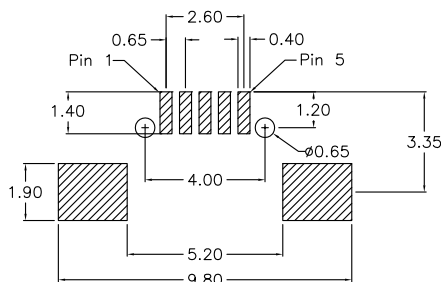
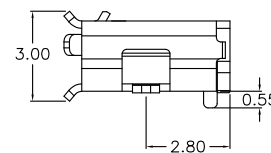
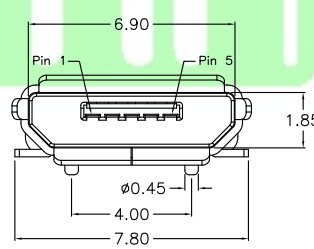
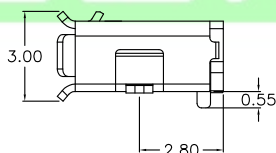
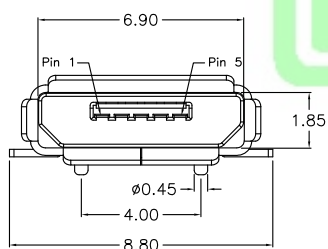
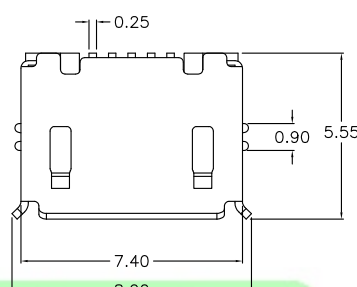

P.C.Board Layout

Ordering information

8971- Series	AB AB:AB Type B:B Type	05 Position	G G:Gold Plated	00 00: G/F 30: 30u"	D D: SMD Type	P P: With Post N: Without Post	T T: Tape & Reel Package U: Tube Package
------------------------	-------------------------------------	-----------------------	---------------------------	----------------------------------	-------------------------	---	---

Information including designs, specifications and components may be changed or updated without notice.

A163