

# 8972-B Series

## USB 3.0 B Type

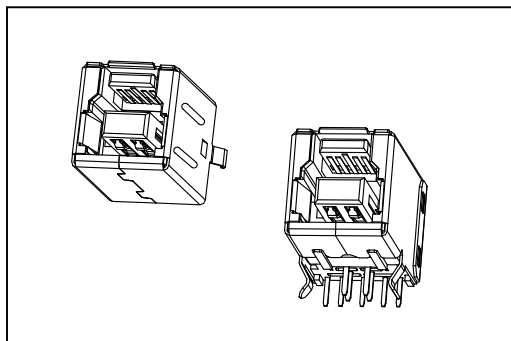

### Material:

Housing: Thermoplastic Polyester Glass Filled UL94V-0.

Contacts: Copper Alloy.

Shell: Copper Alloy.

### Electrical Characteristics:

Current Rating: 1.8 A/0.25 A .

Dielectric Withstanding Voltage: AC 100V .

Insulator Resistance: 100MΩ min.

Contact Resistance: 50mΩ max.

Operating Temperature: -55°C ~ +85°C.

8972-B09C30SUA

8972-B09C30RUA

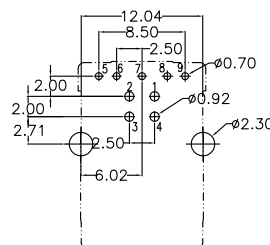
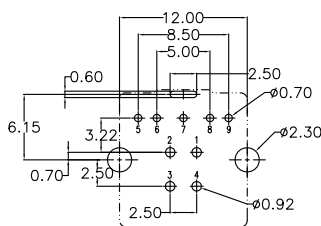
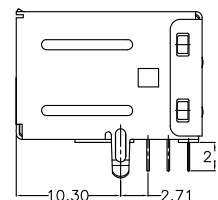
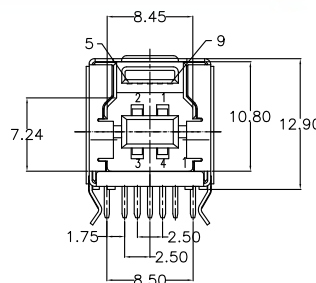
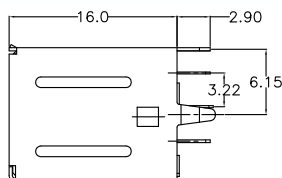
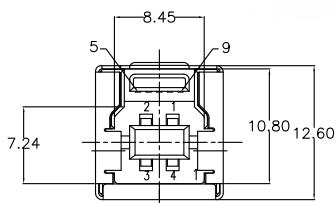
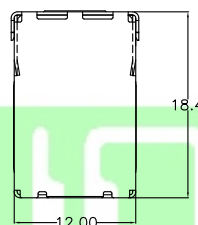
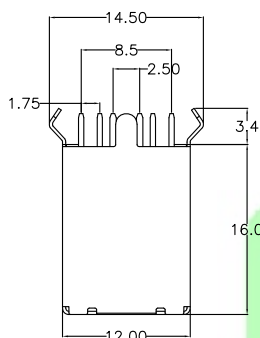

P. C. Board Layout

P. C. Board Layout

## Ordering information

**8972-B**  
Series

**09**  
Position

**C**  
C: Selective  
Gold Plated

**30**  
30: 30 u"

**S**  
S: Straight  
R: Right Angle

**U**  
U: Blue

**A**  
A: Tray Package