

9001 Series

DIN41612 Half Q Type Male

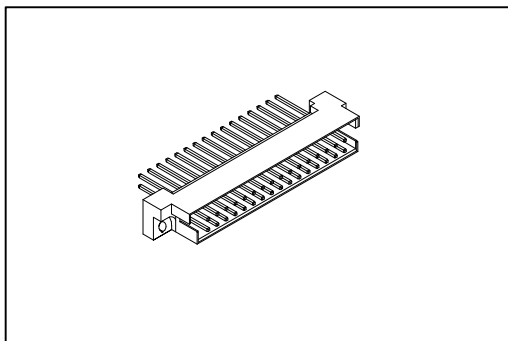

Material:

Housing: Thermoplastic Polyester Glass Filled UL94V-0.

Contacts: Copper Alloy.

Electrical Characteristics:

Current Rating: 2 A.

Dielectric Withstanding Voltage: AC 1000V.

Insulator Resistance: 1000MΩ min.

Contact Resistance: 20mΩ max.

Operating Temperature: -55°C ~+125°C.

Features:

- * Mates with Female 2Row Half
9001-36 Half B Type.
9001-38 Half Q Type.

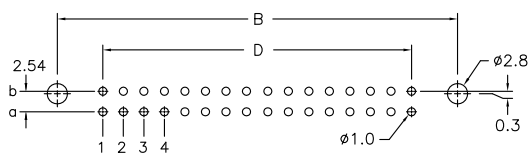
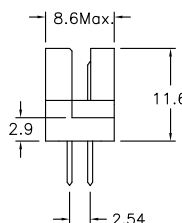
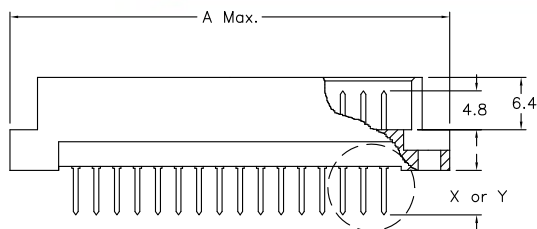
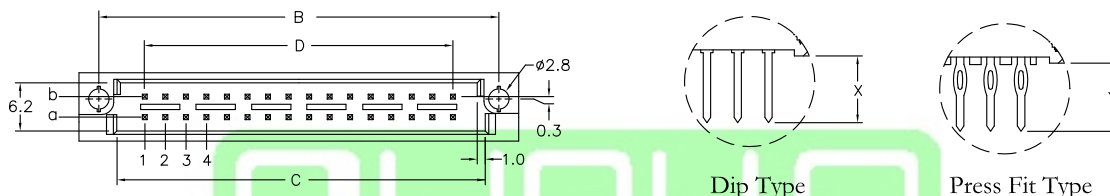

P.C. Board Layout

Length	1	2	W1	W2
X	4.0	2.5	13	17
Y	4.6	6.3	13	17

Dimension				
Position	A	B	C	D
32/16/8	55.0	49.36	44.60	38.10
20/10/5	39.8	34.12	29.36	22.86
Pitch	Position	Rows with Contacts	Contact Arrange	
2.54mm	32	a b		
	20	a b		
	16	a -		
	10	a -		
5.08mm	16	a b		
	10	a b		
	8	a -		
	5	a -		

Ordering information

9001-	3	7	32	1	C	00	P	L1	A
Series	3: 2.54mm 4: 5.08mm	7: Male	Position	1: Dip Length 2: Dip Length W1: Dip Length W2: Dip Length	C: Selective Gold Plated	00: G/F	Blank: Dip P: Press Fit	Blank: W/O Lock L1: With Lock See Page CA03	A: Tray Package

9001 Series

DIN41612 Mating Introduce



2 Row insulator
B (Standard mounting)
Mounting axis
of the connector

3 Row insulator
C (Standard mounting)
Mounting axis
of the connector

Board lock available
L1=P.C.B. Thickness 1.6 ~2.0 mm
L2=P.C.B. Thickness 2.8 ~3.2 mm

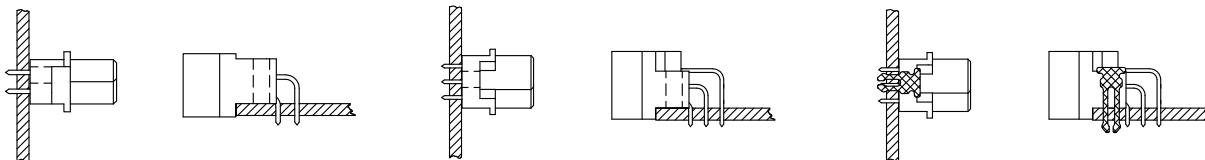

Q (Reverse mounting)
Mounting axis
of the connector

R (Reverse mounting)
Mounting axis
of the connector

Board lock available
L1=P.C.B. Thickness 1.6 ~2.0 mm
L2=P.C.B. Thickness 2.8 ~3.2 mm

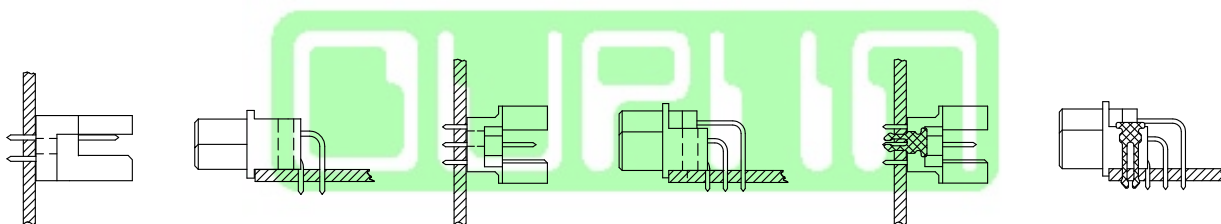

I.D.C. Type Ribbon Cable

Press Fit Type
2 Row insulator

3 Row insulator

2 Row insulator

3 Row insulator

