

9111 Series

Hard Metric Connector Female Right Angle Type D

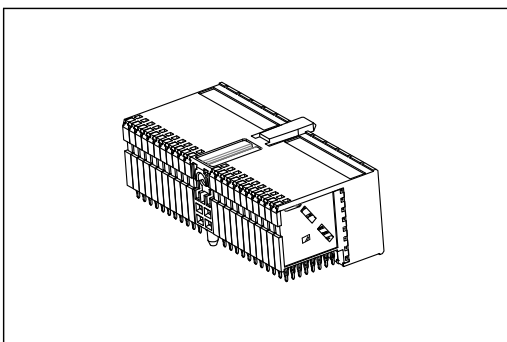

Material:

Housing: Thermoplastic Polyester Glass Filled UL94V-0.
 Contacts: Copper Alloy.

Electrical Characteristics:

Current Rating : 1 A.
 Dielectric Withstanding Voltage: AC 750V.
 Insulator Resistance: 10000MΩ min.
 Contact Resistance: 20mΩ max.
 Operating Temperature: -55°C ~+125 °C.

Features:

* Type D Right Angle Female.
 8 X 22 Position Fully Loaded.

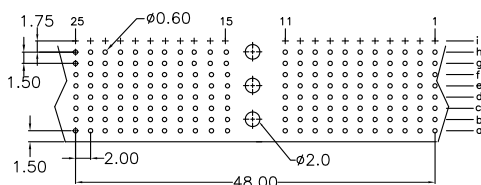
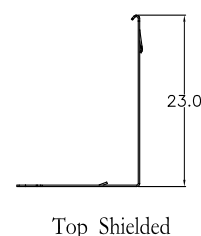
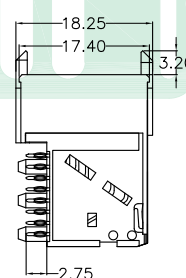
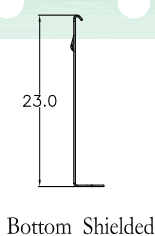
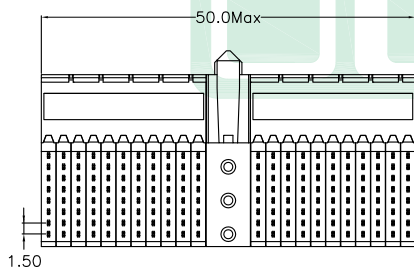
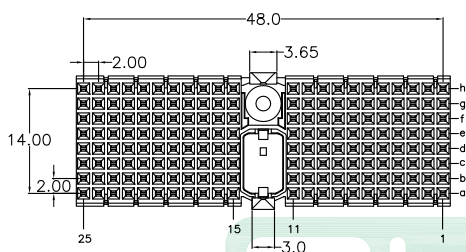

P.C. Board Layout

Ordering information

<u>9111-</u>	<u>10</u>	<u>2</u>	<u>D</u>	<u>176</u>	<u>1</u>	<u>CB</u>	<u>30</u>	<u>A</u>
Series	10Row	2: Female	D: Type D	Position	1: None Shielded 2: Top Body Shielded 3: Top Body Shielded and Bottom Shielded (Package Separately)	CB: Contact Au+Pd/Ni, Dip Tin plated	30: 30μ"	A: Tray Package

Information including designs, specifications and components may be changed or updated without notice.