

9111 Series

Hard Metric Connector Female Right Angle Type E

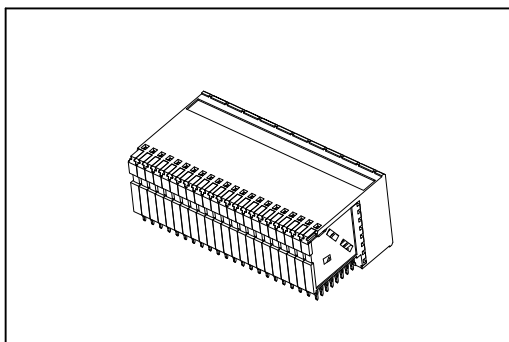

Material:

Housing: Thermoplastic Polyester Glass Filled UL94V-0.
 Contacts: Copper Alloy.

Electrical Characteristics:

Current Rating : 1 A.
 Dielectric Withstanding Voltage: AC 750V.
 Insulator Resistance: 10000MΩ min.
 Contact Resistance: 20mΩ max.
 Operating Temperature: -55°C ~+125 °C.

Features:

* Type E Right Angle Female.
 8 X 25 Position Fully Loaded.

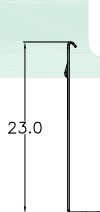
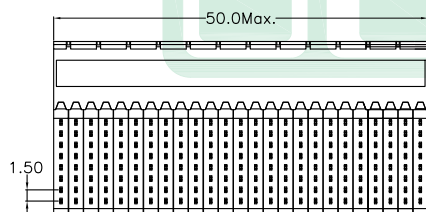
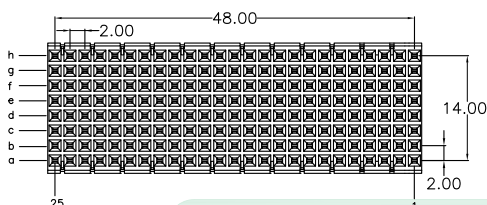

Bottom Shielded

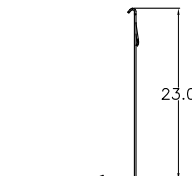
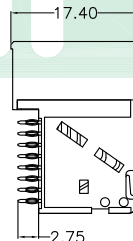

Top Shielded

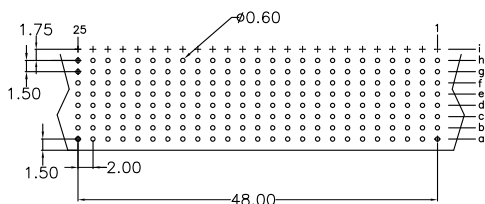

P.C. Board Layout

Ordering information

9111-	10	2	E	200	1	CB	30	A
Series	10Row	2: Female	E: Type E	Position	1: None Shielded 2: Top Body Shielded 3: Top Body Shielded and Bottom Shielded (Package Separately)	CB:Contact Au+Pd/Ni, Dip Tin plated	30: 30μ"	A: Tray Package

Information including designs, specifications and components may be changed or updated without notice.

CE35