

9111-A Series

H.D 2.0mm(0.079") Futurebus(+) 4 Rows Female Right Angle Type

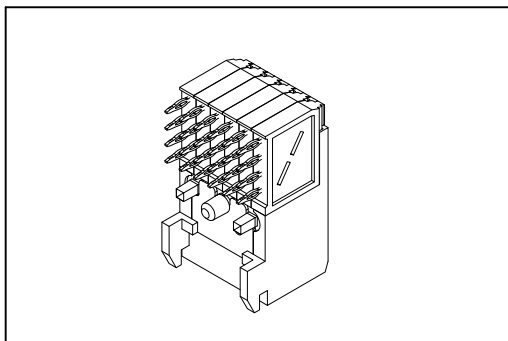

Material:

Housing: Thermoplastic Polyester Glass Filled UL94V-0.
 Contacts: Copper Alloy.

Electrical Characteristics:

Current Rating: 2 A.
 Dielectric Withstanding Voltage: AC 1500V.
 Insulator Resistance: 1000MΩ min.
 Contact Resistance: 20mΩ max.
 Operating Temperature: -55°C ~+125°C.

Features:

- * 2mm high density futurebus+ female right angle solder and Press Fit Type.
- * Available pin count from 24~48.
- * Side by side stackable.
- * Push-Fit peg.

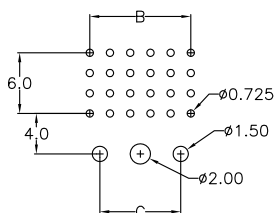
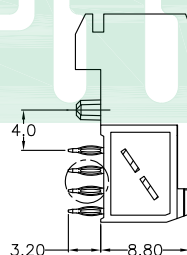
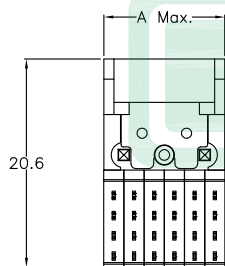
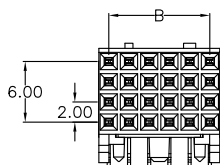

P.C. Board Layout

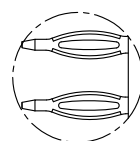

Press Fit Type

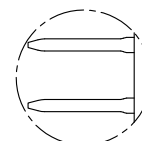

Dip Type

Position	Dimension		
	A	B	C
24	11.95	10.0	8.0
48	23.95	22.0	20.0

Ordering information

9111-A 4 2 24 1 1 CB 30 D U
 Series 4: 4 Rows 2: Female Position 1: Dip Length 0: None Metal Plate 1: With Metal Plate CB:Contact Au+Pd/Ni, Dip Tin plated 30: 30 μ" D: Dip Type P: Press Fit Type U: Tube Package

Information including designs, specifications and components may be changed or updated without notice.

CD03