

REV.	SPECIFICATION	ECN NO.	APPD.

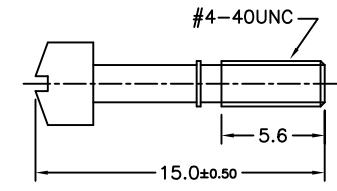

HW-S120EN00

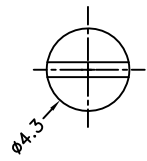
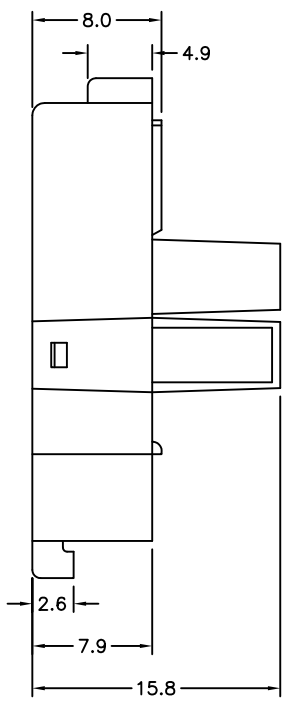
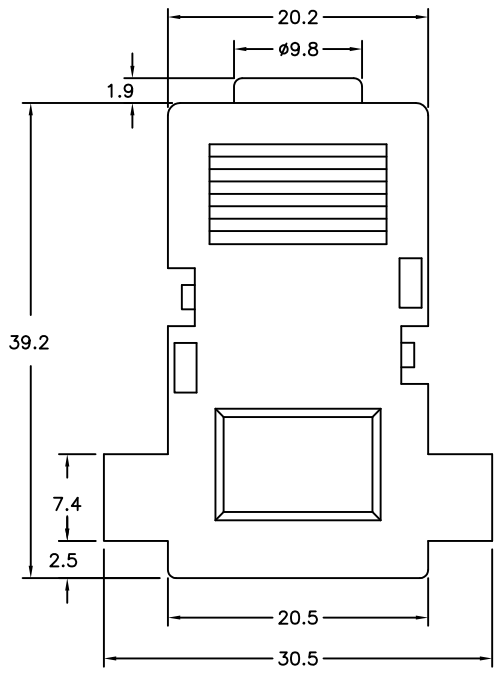
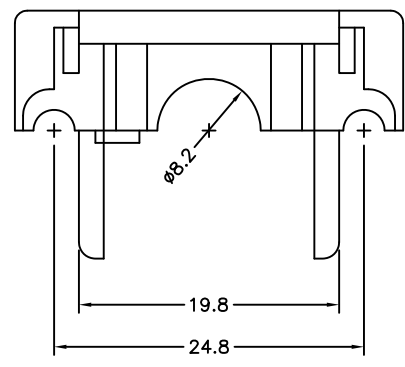
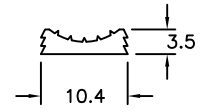
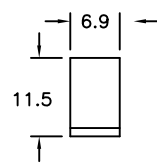
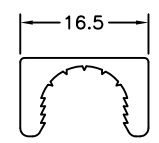

DP- 09      Q      Y      B  
 Series   Position   Q: Quick   Y: Grey   B: Bulk Package  
                          Lock        B: Black       P: Individual Package  
    C: Chrome  
    (Plastic Metallized)

Tolerances	Dwg. No.	DP00D00005	Title:		<b>OUPIN</b> OUPIN ELECTRONIC(KUNSHAN) CO., LTD.
x = ±0.80	Projection		DP Series		
.x = ±0.50	Unit	mm	Scale	1:1	P/N: DP-09QYB
.xx = ±0.35	Drawn By	Vic Lyu11/09'15	① 741		SHEET 1/1
					Ver.No. A4