

REV.	SPECIFICATION	ECN NO.	APPD.

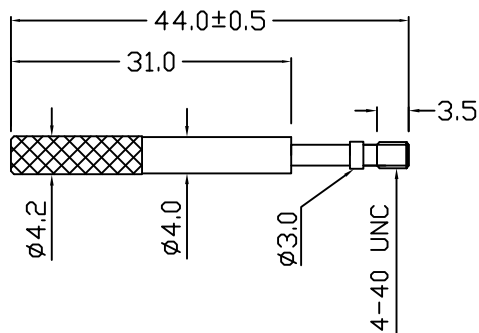

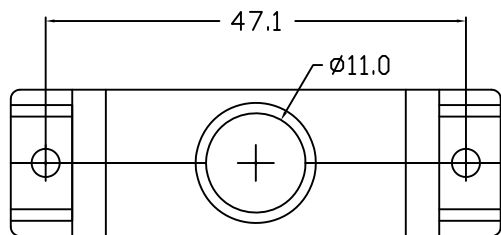

Material:
 Housing: Thermoplastic Polyester Glass Filled UL94HB.
 Screw: Metal.
***RoHS Compliant**

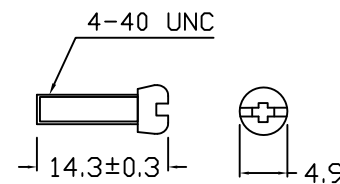
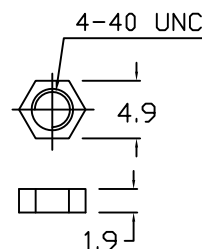
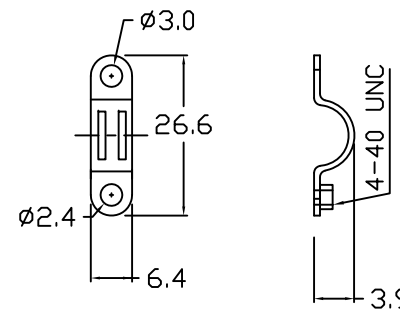
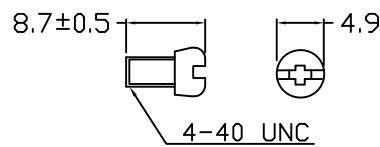
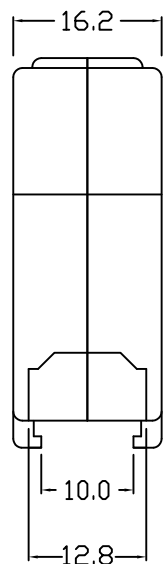
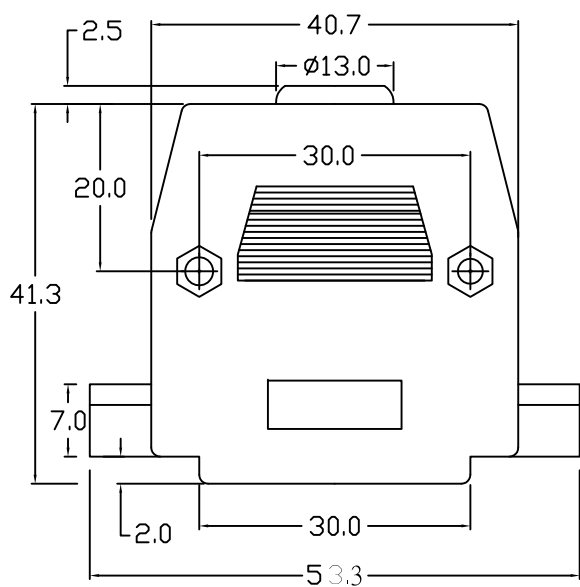

DP- 25 Y
 Series Position Y:Grey
 B:Black
 C:Chrome
 (Plastic metallized)

SL B
 SL:Long Screw B:Bulk Package
 P:Individual Package

Tolerances	Dwg. No.	DP00D00014	Title:		 OUPIIN ELECTRONIC(KUNSHAN) CO., LTD. P/N: DP-25YSLB
x = ±0.80	Projection		DP Series		
.x = ±0.50	Unit	mm	Scale	1:1	
.xx = ±0.35	Drawn By	Scott 07/12'16	⑦ 741		SHEET
					1/1
					Ver.No.
					B3