

https://www.phoenixcontact.com/cn/products/0707086



Panel feed-through terminal block - HDFK 4 - 0707086

Please be informed that the data shown in this PDF Document is generated from our Online Catalog. Please find the complete data in the user's documentation. Our General Terms of Use for Downloads are valid (<http://phoenixcontact.com/download>)



Panel feed-through terminal block, Connection method: Screw connection, Screw connection, Load current : 41 A, Cross section: 0.2 mm² - 6 mm², AWG 24 - 10, Connection direction of the conductor to plug-in direction: 0 °, Width: 8.1 mm, Color: gray



Key Commercial Data

Packing unit	50 STK
GTIN	 4 017918 003869
GTIN	4017918003869
Custom tariff number	8536901900
Sales Key	AABBDA

Technical data

General

Number of levels	1
Number of connections	2
Nominal cross section	4 mm ²
Color	gray
Insulating material	PA
Flammability rating according to UL 94	V0
Rated surge voltage	6 kV
Degree of pollution	3
Overvoltage category	III
Insulating material group	I
Connection in acc. with standard	IEC 60947-7-1
Nominal current I _N	32 A
Maximum load current	41 A
Nominal voltage U _N	400 V (With metal panels of 1 mm ... 2.5 mm)
	250 V (With metal panels over 2.5 mm ... 4 mm)

<https://www.phoenixcontact.com/cn/products/0707086>

Panel feed-through terminal block - HDFK 4 - 0707086

Technical data

General

	400 V (With plastic panels of 1 mm ... 4 mm)
Open side panel	No
Number of positions	0

Dimensions

Width	8.1 mm
Plate thickness	1 mm ... 4 mm

Connection data

Connection side	Level 1 ext. 1
Connection method	Screw connection
Conductor cross section solid min.	0.2 mm ²
Conductor cross section solid max.	6 mm ²
Conductor cross section flexible min.	0.2 mm ²
Conductor cross section flexible max.	4 mm ²
Conductor cross section AWG min.	24
Conductor cross section AWG max.	10
Conductor cross section flexible, with ferrule without plastic sleeve min.	0.25 mm ²
Conductor cross section flexible, with ferrule without plastic sleeve max.	4 mm ²
Conductor cross section flexible, with ferrule with plastic sleeve min.	0.25 mm ²
Conductor cross section flexible, with ferrule with plastic sleeve max.	4 mm ²
2 conductors with same cross section, solid min.	0.2 mm ²
2 conductors with same cross section, solid max.	1.5 mm ²
2 conductors with same cross section, stranded min.	0.2 mm ²
2 conductors with same cross section, stranded max.	1.5 mm ²
2 conductors with same cross section, stranded, ferrules without plastic sleeve, min.	0.25 mm ²
2 conductors with same cross section, stranded, ferrules without plastic sleeve, max.	1.5 mm ²
2 conductors with same cross section, stranded, TWIN ferrules with plastic sleeve, min.	0.5 mm ²
2 conductors with same cross section, stranded, TWIN ferrules with plastic sleeve, max.	2.5 mm ²
Cross section with insertion bridge, solid max.	4 mm ²
Cross section with insertion bridge, stranded max.	2.5 mm ²
Stripping length	9 mm
Internal cylindrical gage	A4
Screw thread	M3
Tightening torque, min	0.6 Nm
Tightening torque max	0.8 Nm
Connection side	Level 1 int. 1
Connection method	Screw connection
Conductor cross section solid min.	0.2 mm ²

<https://www.phoenixcontact.com/cn/products/0707086>



Panel feed-through terminal block - HDFK 4 - 0707086

Technical data

Connection data

Conductor cross section solid max.	6 mm ²
Conductor cross section flexible min.	0.2 mm ²
Conductor cross section flexible max.	4 mm ²
Conductor cross section AWG min.	24
Conductor cross section AWG max.	10
Internal cylindrical gage	A4

Standards and Regulations

Connection in acc. with standard	CSA
	IEC 60947-7-1
	IEC / EN
Flammability rating according to UL 94	V0

Environmental Product Compliance

China RoHS	Environmentally Friendly Use Period = 50
	For details about hazardous substances go to tab "Downloads", Category "Manufacturer's declaration"

Drawings

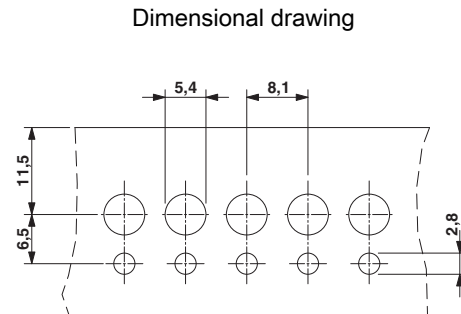
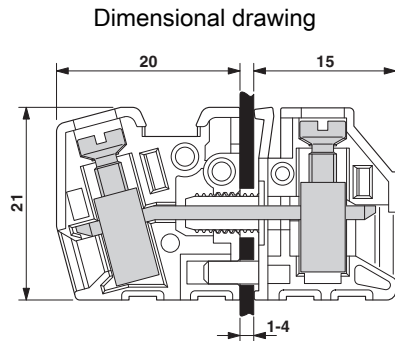

Approvals

Approvals

Approvals

CSA / KEMA-KEUR / PRS / IECCEB Scheme / cULus Recognized / EAC

Ex Approvals

Approval details

<https://www.phoenixcontact.com/cn/products/0707086>





Panel feed-through terminal block - HDFK 4 - 0707086

Approvals

CSA		http://www.csagroup.org/services/testing-and-certification/certified-product-listing/	13631
mm ² /AWG/kcmil		22-10	
Nominal current IN		30 A	
Nominal voltage UN		300 V	

KEMA-KEUR		http://www.dekra-certification.com	2169260.01
mm ² /AWG/kcmil		4	
Nominal current IN		32 A	
Nominal voltage UN		250 V	

PRS		http://www.prs.pl/	TE/1825/880590/09
-----	---	---	-------------------

IECEE CB Scheme		http://www.iecee.org/	NL-29947
mm ² /AWG/kcmil		4	
Nominal current IN		32 A	
Nominal voltage UN		250 V	

cULus Recognized		http://database.ul.com/cgi-bin/XYV/template/LISEXT/1FRAME/index.htm	E60425-19870911
	B	D	
mm ² /AWG/kcmil	30-10	30-10	
Nominal current IN	30 A	10 A	
Nominal voltage UN	300 V	300 V	

EAC		B.01742
-----	---	---------

<https://www.phoenixcontact.com/cn/products/0707086>



Phoenix Contact 2017 © - all rights reserved
<http://www.phoenixcontact.com>