

HSF

NOTES:

Current Rating: 3.0AMP
 Contact Resistance: 20mΩ Max
 Withstand Voltage: 1000V AC/DC
 Insulation Resistance: 1000MΩ Min
 Operation Temperature: -40°C to +105°C

Contact Material: Brass Or Phosphor Bronze
 Contact plating: Au Or Sn over Ni
 Insulator Material: PBT+30%G.F UL94V-0

6P Without Slot "M" and "N"
 8P-12P With Slot "M", Without Slot "N"
 14P-64P With Slot "M" and "N"

Ordering Information

5212-XX Y B XX B X 01

Two Parts Conn+Cover	No. of Pins 06P 26P 08P 30P 10P 34P 12P 36P 14P 40P 16P 44P 18P 50P 20P 60P 22P 64P 24P	Contact Material B=Brass P=Phosphor Bronze	Contact Plating S0=Gold Flash/Ni S3=10u"Gold/Ni S4=15u"Gold/Ni S5=30u"Gold/Ni SN=Tin	Color Insulator B=Black G=Grey(427C)	Bump N=W/O Bump W=With Bump
-------------------------	---	---	---	--	-----------------------------------

Item	Pitch	Mating
Standard	2.54	3110/3210
Alternate		

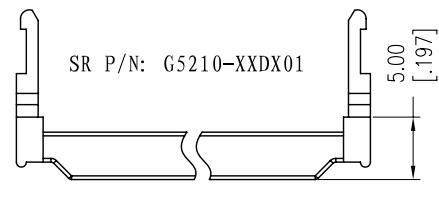
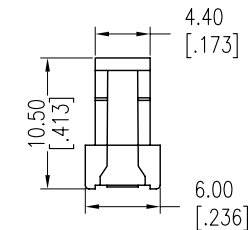
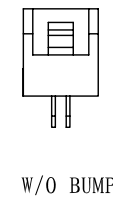
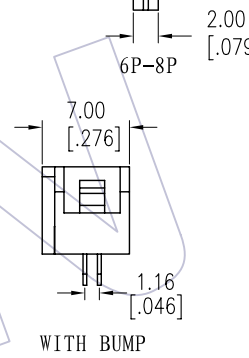
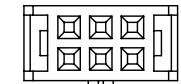
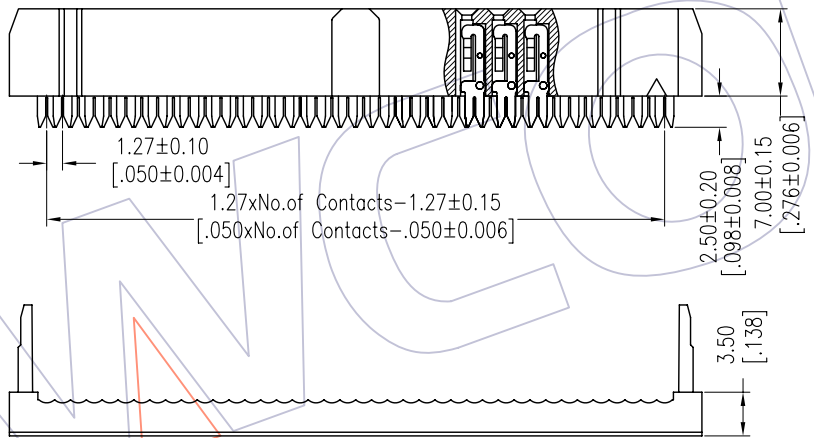
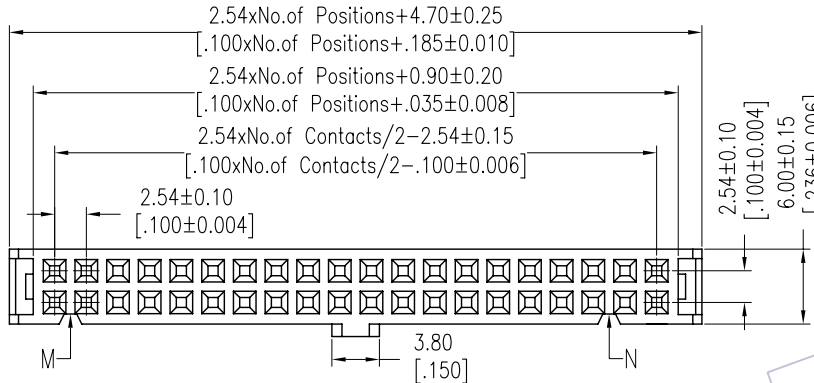

BUTTERFL SR P/N: G5210-XXDX02

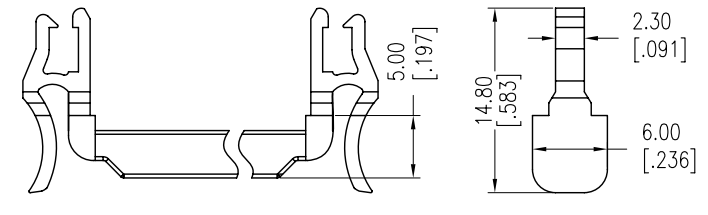

REV	DATE	MODIFICATION DESCRIPTION	CHANGE	OPERATION	DRAW	DATE	SCALE	FIT	PART NO.
				X.X ±0.40	JYHuang	2012/12/28	UNIT	mm	5212-XXYBXXBX01
				X.XX ±0.25	CHECK	DATE	SIZE	A4	TITLE:
A0	2012/12/28	NEW	-----	X.XXX ±0.15	APPROVE	DATE	SHEET	1/1	2.54 IDC SOCKET+SR (ONE SIDE CONTACT)
				Angle ± 3'	APPROVE	DATE	PROJ.		Customer NO.
				DIM TOL					