

HSF

NOTES:
 Current Rating:1AMP
 Contact Resistance:20mΩ max
 Withstand Voltage:500V AC/DC
 Insulation Resistance:1000MΩ min
 Operation Temperature:-40°C to +105°C

Contact Material:Phosphor Bronze
 Contact plating:Au or Sn over Ni
 Insulator Material:PBT+30%GF(UL94V-0)

Ordering Information

6310 - 050 S S SX M N A 01

No. of Pins
50Pin

Contact Plating
 S4=15u"Gold/Tin
 S5=30u"Gold/Tin

Packing
 A=Tray

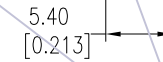
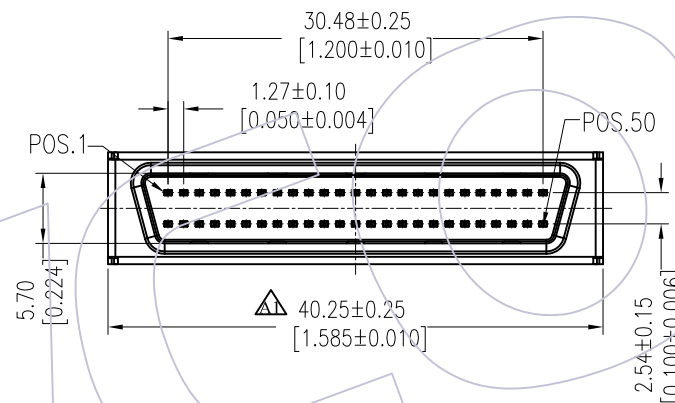
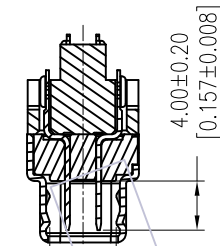
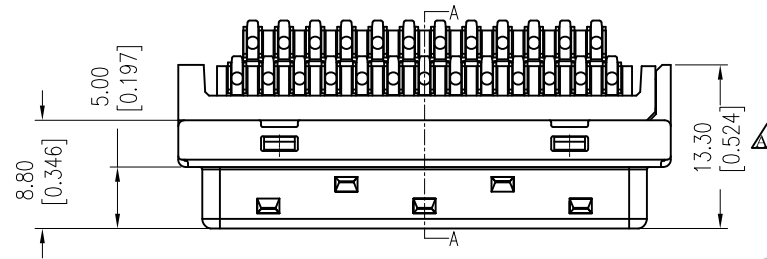

SECTION: A-A

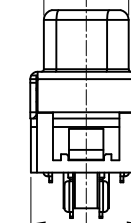
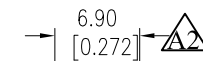
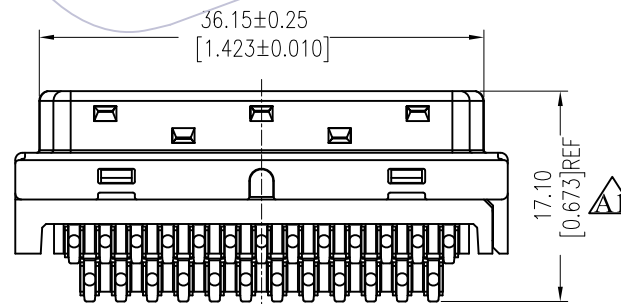

REV	DATE	MODIFICATION DESCRIPTION	CHANGE	OPERATION	DRAW	DATE	SCALE	FIT	PART NO.
A2	2013/01/26	Modify The Dimension 7.00 → 6.90		X.X ±0.40	Tsingsn	2013/01/26	UNIT	mm	6310-050SSSXMA01
A1	2012/04/19	MODIFY		X.XX ±0.25	CHECK	DATE	inch	TITLE:	
A0	2012/03/19	NEW		X.XXX ±0.15	APPROVE	DATE	SIZE	A4	1.27x2.54 SCSI 50P Male Soldering Type
				Angle ± 3'			SHEET	1/1	Customer NO.
				DIM TOL			PROJ.		