

SD Memory Card Connectors

DM1 Series



■ Features

1. Withstands higher force of card insertion

Metal cover extends over the back of the connector allowing it to withstand force of up to 400N (static load) when dropped or accidentally hit. (Fig.1)

2. No damage to the card when accidentally pulled-out

The connectors will release the card when a moderate pull-out force of about 4N is applied. There will be no damage to the lock components and all connector functions will not be affected. (Fig.2)

3. Accidental card fall-out prevention

Built-in lock feature holds the card securely in place. (Fig.3)

4. Reliable Card Insertion and Withdrawal

Built-in Push-in / Push-out ejection mechanism assures simple and reliable card insertion and withdrawal.

5. Designed to accept Secure Digital I/O card (Built-in Ground Contact)

The connector allows use of various expansion modules, including the Bluetooth communication modules.

Withstands higher force of card insertion.

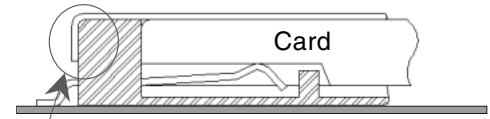

Standard type

Metal cover extends over the back of the connector.

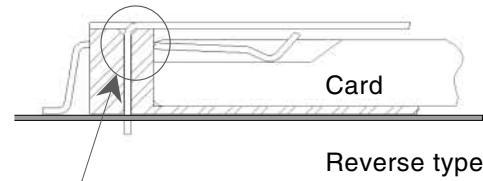

Reverse type

Metal cover extends over the back of the connector.

Fig.1

No damage to the card when accidentally pulled-out.

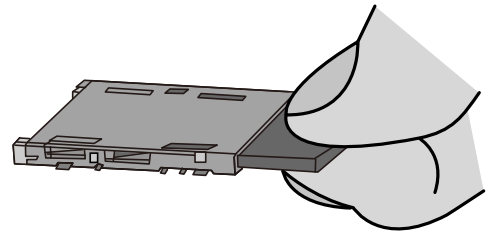

Fig.2

Accidental card fall-out prevention

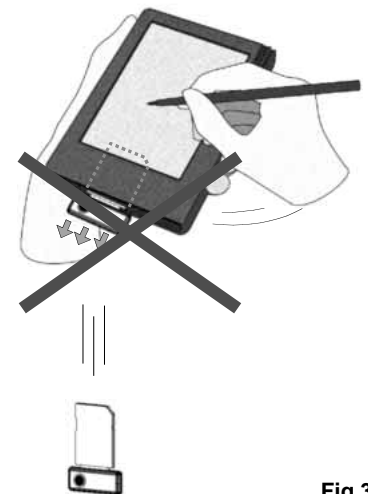

Fig.3

Product Specifications

Rating	Current rating 0.5A DC Voltage rating 125V AC	Operating temperature range : -25°C to +85°C (Note 1) Storage temperature range : -40°C to +85°C (Note 2)	Operating humidity range : Relative humidity 95% max. (No condensation)
--------	--	--	---

Item	Specification	Conditions
1. Insulation resistance	1000MΩ min. (Initial value)	500V DC
2. Withstanding voltage	No flashover or insulation breakdown	500V AC / one minute
3. Contact resistance	100mΩ max. (Initial value)	100mA DC
4. Vibration	No electrical discontinuity of 100ns or more	Frequency : 10 to 55Hz, single amplitude of 0.75mm, 2 hours / 3 axis
5. Humidity	Contact resistance : 40mΩ max. from initial value Insulation resistance : 100MΩ min.	96 hours at temperature of 40°C ± 2°C and humidity of 90% to 95%
6. Temperature cycle	Contact resistance : 40mΩ max. from initial value Insulation resistance : 100MΩ min.	Temperature : -55°C → +5°C to +35°C → +85°C → +5°C to +35°C Duration : 30 → 5 → 30 → 5 (Minutes) 5 cycles
7. Durability (mating/un-mating)	Contact resistance : 40mΩ max. from initial value	10000 cycles at 400 to 600 cycles per hour
8. Resistance to soldering heat	No deformation of components affecting performance.	Reflow : At the recommended temperature profile Manual soldering : 350°C for 3 seconds

Note1 : Includes temperature rise caused by current flow.

Note2 : The term "storage" refers to products stored for long period of time prior to mounting and use. Operating Temperature Range and Humidity range covers non- conducting condition of installed connectors in storage, shipment or during transportation.

Materials / Finish

Component	Material	Finish	Remarks
Insulator	Heat resistant thermoplastic compound	Color: Black	UL94V-0
Contacts	Phosphor bronze	Contact area: Gold plating Termination area: Tinned copper plating	——
Cover	Stainless steel	Termination area: Tinned copper plating	——
Others	Stainless steel Piano wire	—— Nickel plating	——

Product Number Structure

DM1 AA - SF - PEJ

① ② ③ ④

① Series name	DM1	③ Terminal type	SF : Right angle surface mount
② Connector type	AA : Standard receptacle B : Reverse receptacle		DSF : Reverse right angle surface mount
		④ Eject mechanism codes	PEJ : Card Push insert/Push withdraw

Standard type

PCB mounting pattern



Part No.	HRS No.
DM1AA-SF-PEJ(82)	609-0004-8 82

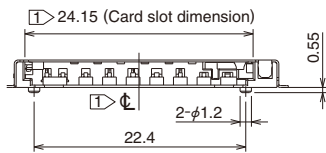
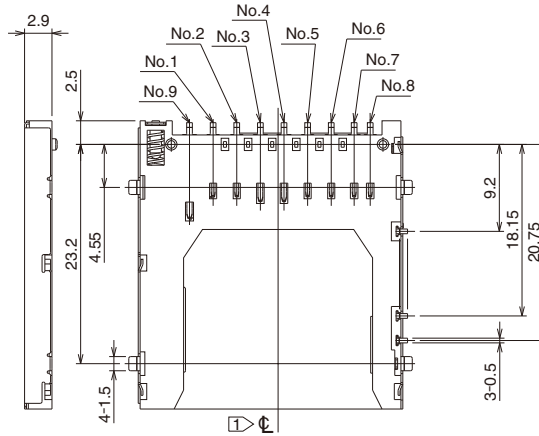
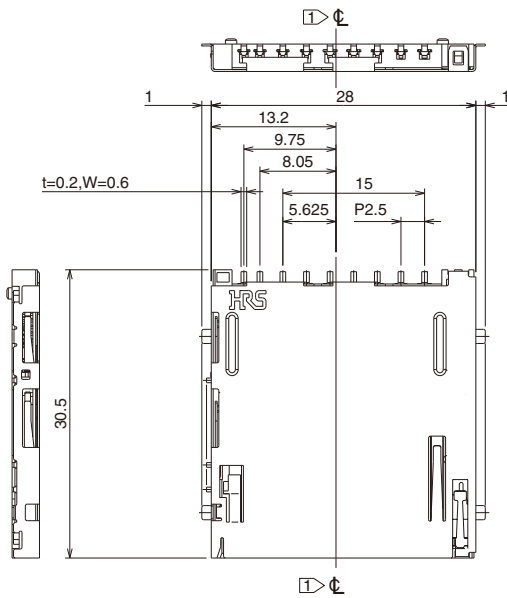
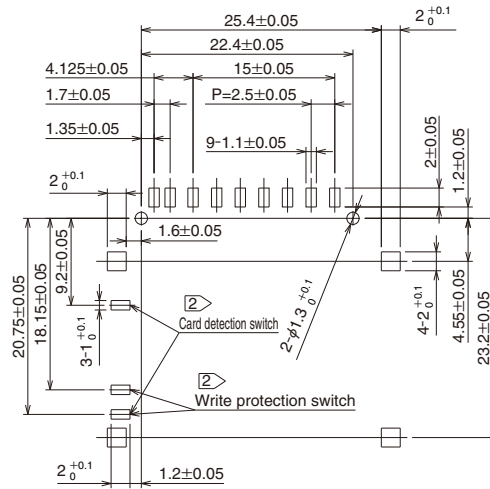

① indicates the center line of card slot.

Card detection switch		Write protection switch		
When card is ejected	When card is inserted	When card is ejected	When card is inserted	
		WRITE PROTECT	WRITE ENABLE	
OPEN	CLOSE	OPEN	OPEN	CLOSE

Weight: 2.2g

Card insertion/withdrawal dimensions

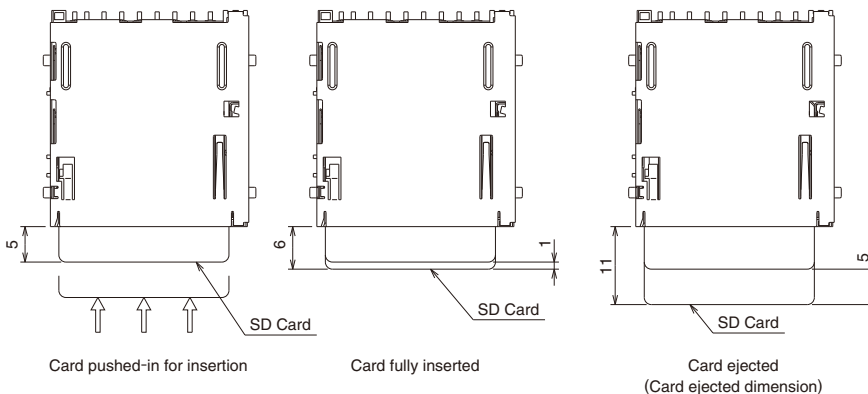

Reverse type

PCB mounting pattern

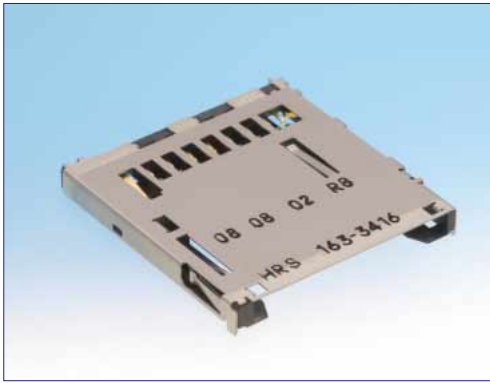

Part No.	HRS No.
DM1B-DSF-PEJ(82)	609-0003-5 82

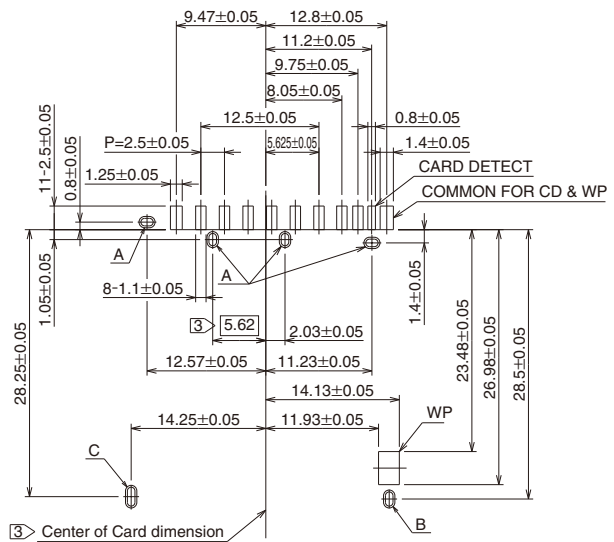

A(5:1)

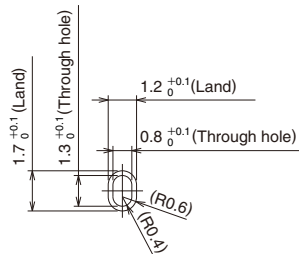

B(5:1)

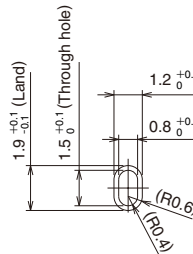

C(5:1)

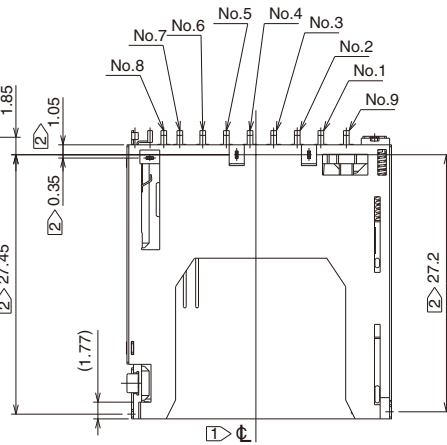
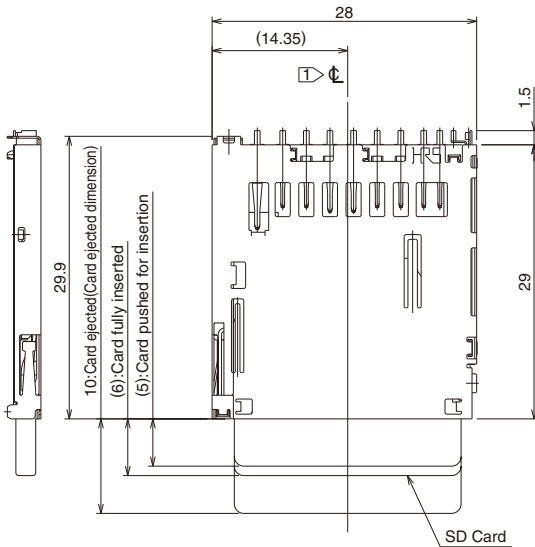
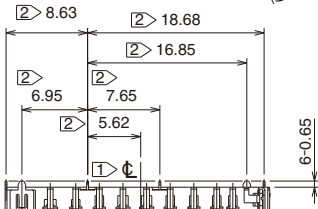
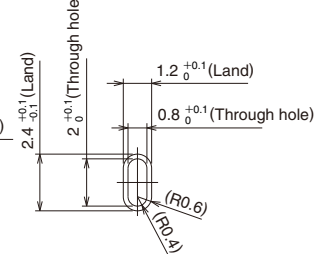

- ① indicates the center line of the card slot.
- ② indicates the dimension of DIP terminals.

Card detection switch		Write protection switch		
When card is ejected	When card is ejected	When card is ejected	When card is ejected	When card is ejected
		WRITE PROTECT	WRITE ENABLE	
OPEN	CLOSE	OPEN	OPEN	CLOSE

Weight: 2.1g

◆Packaging specifications

●Embossed Carrier Tape Dimensions (Standard type) 450 pcs/reel

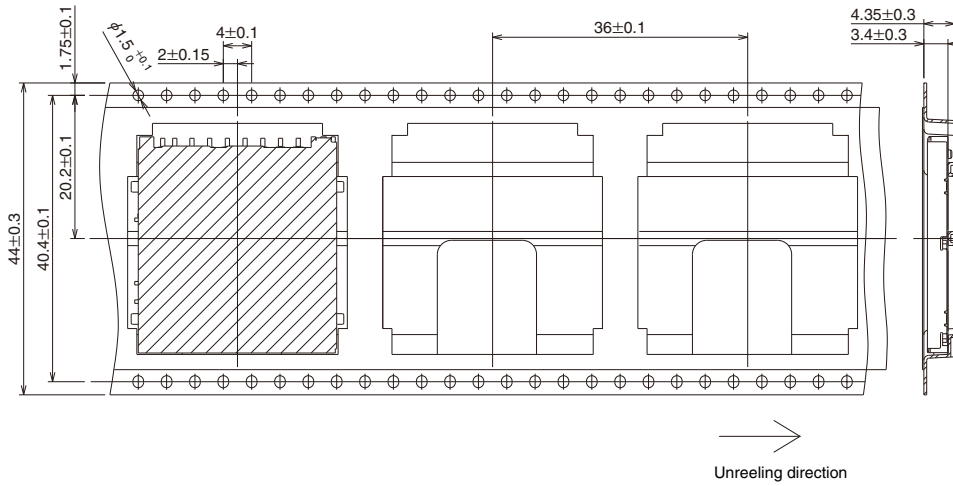

●Embossed Carrier Tape Dimensions (Reverse type) 450 pcs/reel

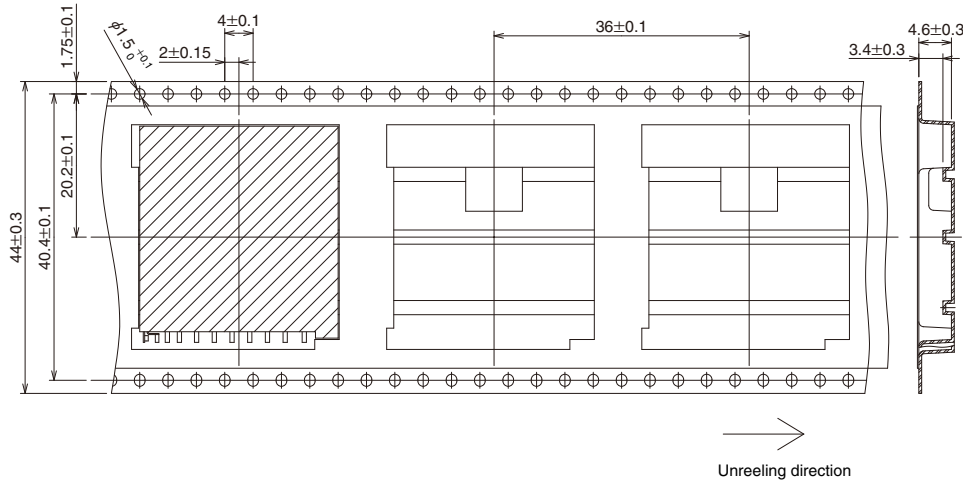

●Reel dimensions

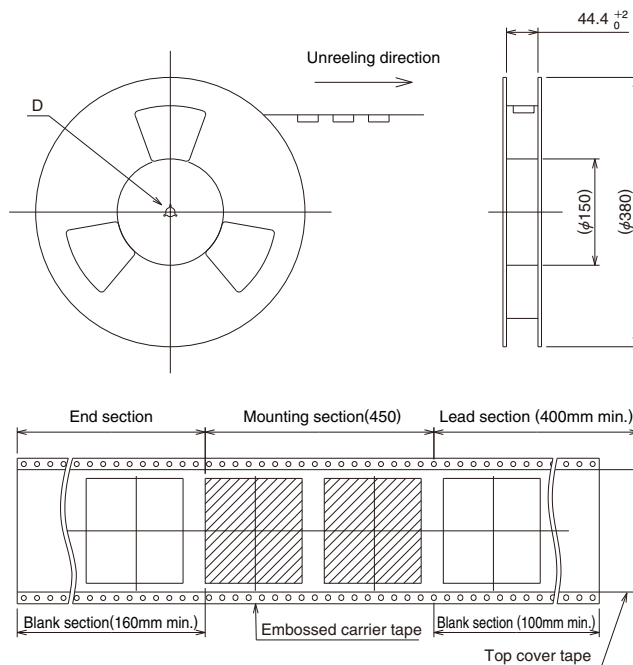

◆ Recommended Temperature Profile

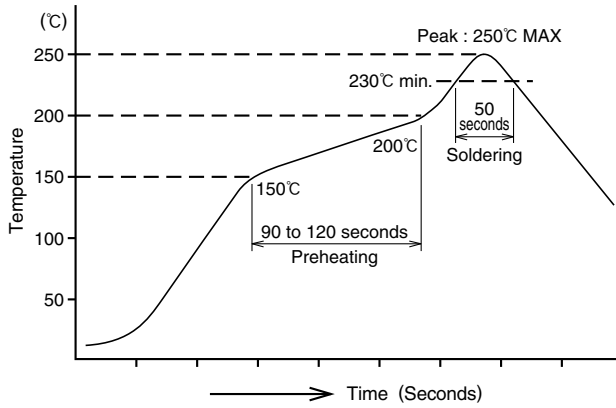

HRS test condition

Solder method : Reflow, IR/hot air

Environment : Room air

Solder composition : Paste, 96.5%Sn/3.0%Ag/0.5%Cu
(Senju Metal Industry, Co., Ltd.'s
Part Number:M705-GRN360-K2-V)

Test board : Glass epoxy 60mm×100mm×1.0mm thick

Metal mask : 0.15mm thick

Number of reflow cycles : 2cycles max.

The temperature profiles shown are based on the above conditions.

In individual applications the actual temperature may vary, depending on solder paste type, volume / thickness and board size / thickness. Consult your solder paste and equipment manufacturer for specific recommendations.