

For Antenna

GT19 Series

— Connectors for window-mounted antennas —

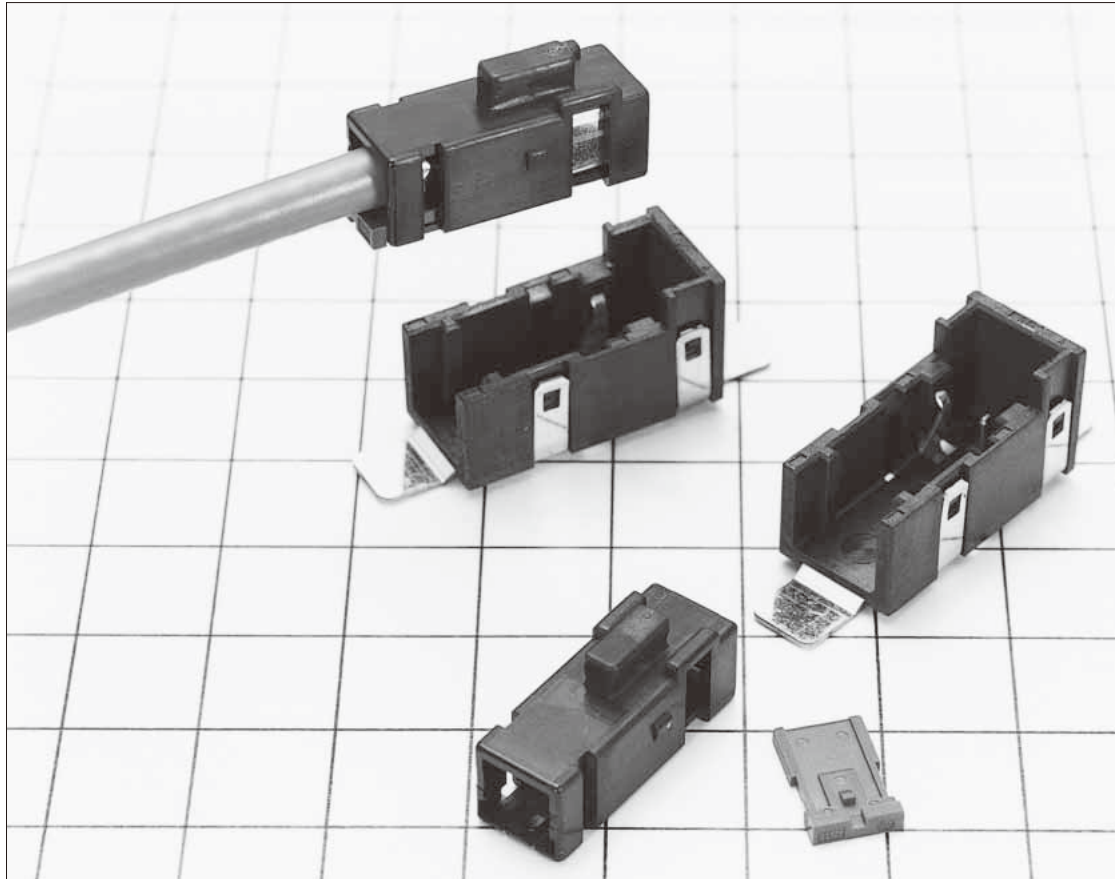

May.1.2016 Copyright 2016 HIROSE ELECTRIC CO., LTD. All Rights Reserved.

■ Features

- **Low cost cable assembly(GT19N)**
Signal lines and shield can be crimped in a batch.
- **Space-saving design(GT19S)**
Compare with GT19N, mounting space is reduced by approximately 27%.

■ Applications

for window-mounted antennas.

For Antenna

- GT5
- GT13
- GT16
- PO5G
- GT19**
- GT21
- GT26
- GT36
- GT11
- GT17
- GT32
- GT3
- GT7
- GT10
- GT18W
- GT25
- GT8E
- GT9
- GT15

GT19N Series

F Connectors

● Terminals

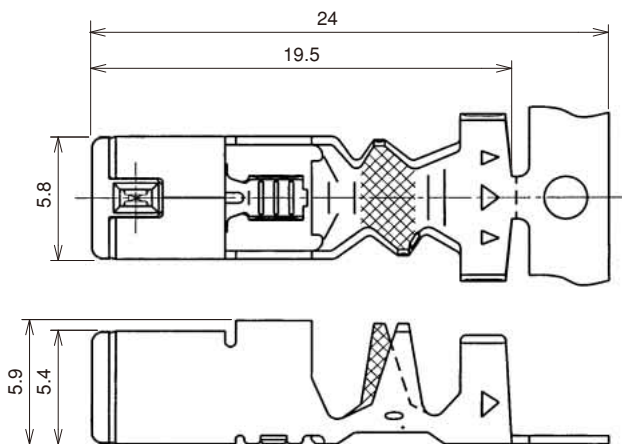
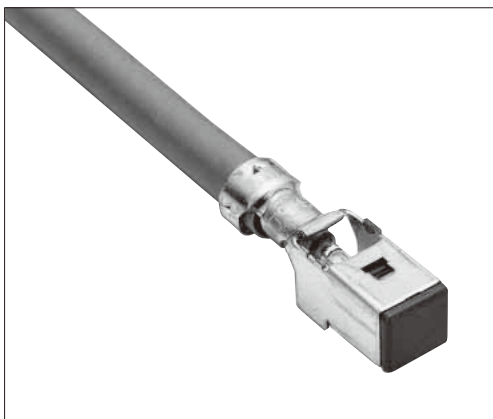

Part No.	HRS No.	Material/Plating or Color	Wire Size	Inner Insulation Diameter	Outer Diameter	Packaging	RoHS
GT19N-2022/F3.3-5SCF(70)	769-0001-1 70	Insulator : PBT/Dark Gray Center terminals : Phosphor bronze/Tin plating Outer terminals : Brass/Tin plating	20 to 22 AWG	φ 2.5 to 2.9	φ 4.6 to 5.0	1,100 pcs/reel	YES

● Housing

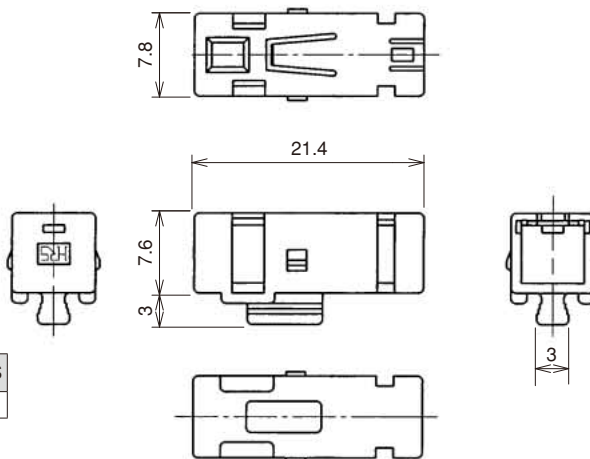
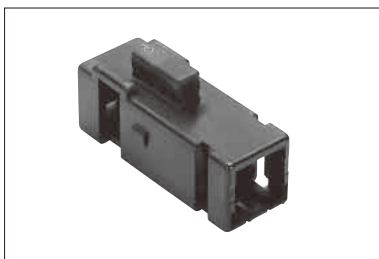

Part No.	HRS No.	Material	Color	Packaging	RoHS
GT19N-1S-HU	769-0002-4	PBT	Black	1	YES

● Retainer (Used with GT19N-1S-HU)

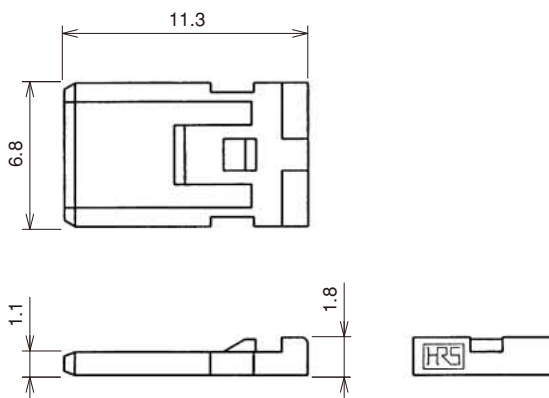
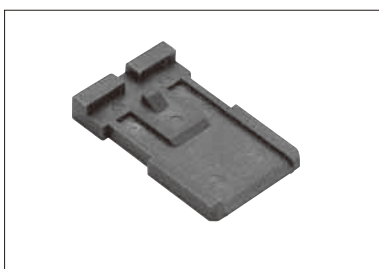

Part No.	HRS No.	Material	Color	Packaging	RoHS
GT19N-1S-R	769-0003-7	PBT	Dark Gray	1	YES

May.1.2016 Copyright 2016 HIROSE ELECTRIC CO., LTD. All Rights Reserved. Antenna

GT5

GT13

GT16

PO5G

GT19

GT21

GT26

GT36

GT11

GT17

GT32

GT3

GT7

GT10

GT18W

GT25

GT8E

GT9

GT15

M Connectors

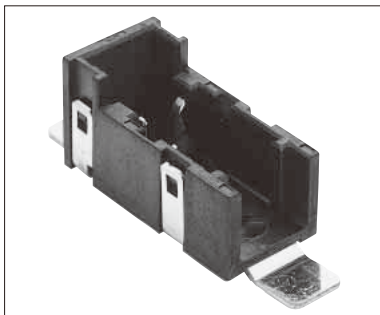

◆ Mated condition

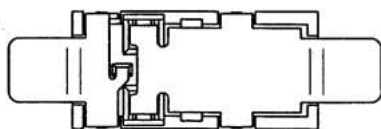
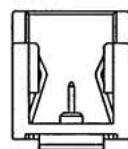
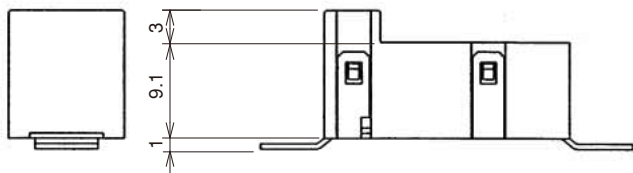
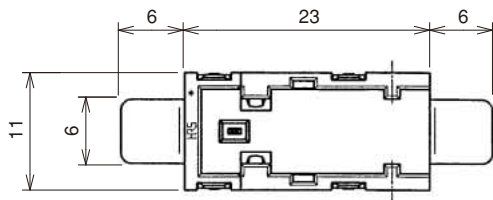
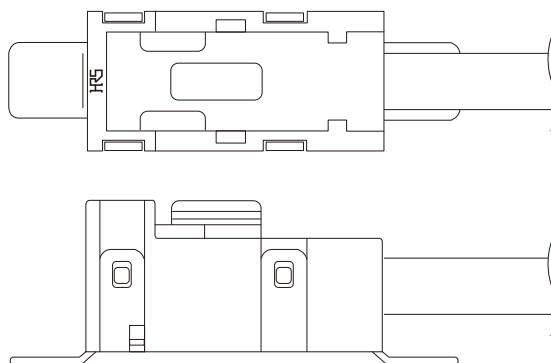

Part No.	HRS No.	Material/Plating or Color	Packaging	RoHS
GT19N-1P-V(70)	769-0004-0 70	Housing : PPS/Black Center terminal : Brass/Tin plating Outer terminal : Copper alloy/Tin plating	1	YES

May.1.2016 Copyright 2016 HIROSE ELECTRIC CO., LTD. All Rights Reserved.

- GT5
- GT13
- GT16
- PO5G
- GT19
- GT21
- GT26
- GT36
- GT11
- GT17
- GT32
- GT3
- GT7
- GT10
- GT18W
- GT25
- GT8E
- GT9
- GT15

GT19S Series

F Connectors

Center terminal

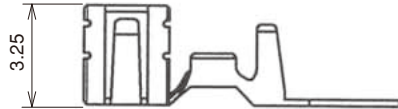
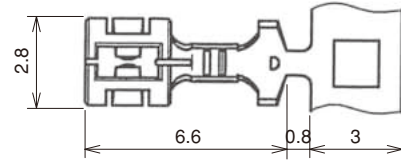

Part No.	HRS No.	Material	Plating	Wire Size	Packaging	RoHS
GT19S-30SCF	769-0014-3	Copper Alloy	Tin plating	30 AWG	3,000 pcs/reel	YES
GT19S-2428SCF	769-0021-9			24 to 28 AWG		

Insulated case

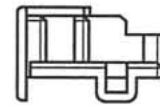
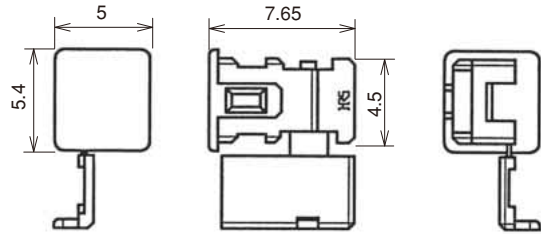
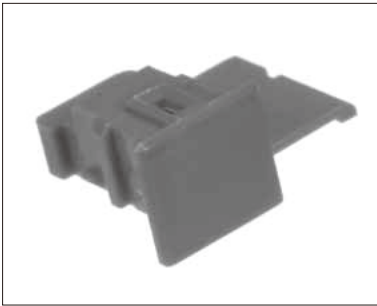

Part No.	HRS No.	Material	Color	Packaging	RoHS
GT19S-SC	769-0015-6	PBT	Dark Gray	1	YES

Outside tube terminal

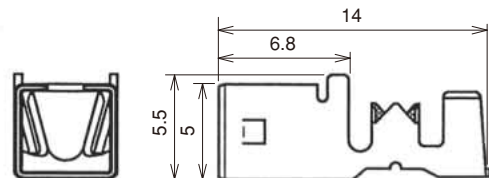
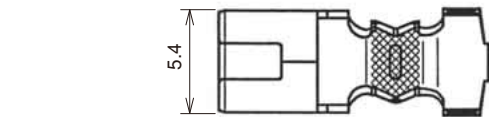

Part No.	HRS No.	Material	Plating	Inner Insulation Diameter	Outer Diameter	Packaging	RoHS
GT19S-1.6-2.9SC	769-0016-9	Brass	Tin plating	φ 1.5 to 2.0	φ 2.6 to 3.0	1	YES

● Housing

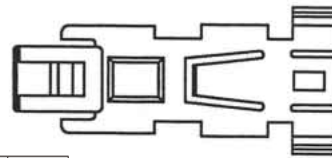
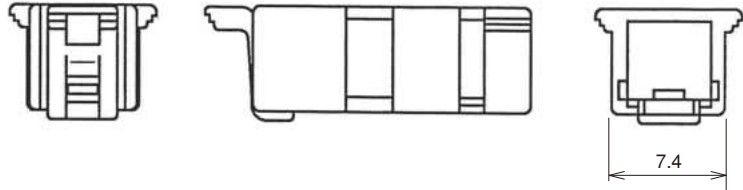
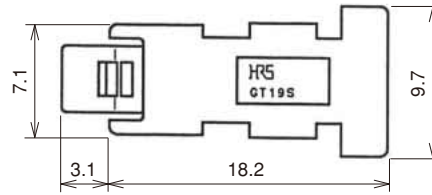
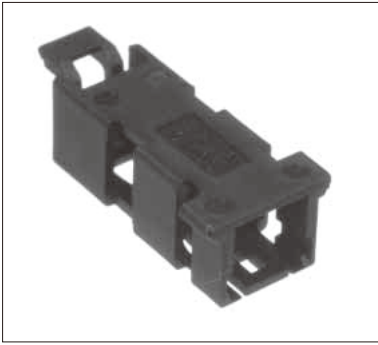

Part No.	HRS No.	Material	Color	Packaging	RoHS
GT19S-1S-HU	769-0017-1	PBT	Black	1	YES

● Retainer (Used with GT19S-1S-HU)

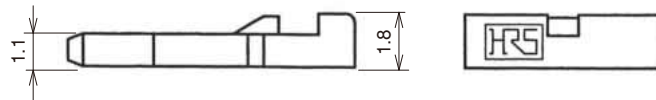
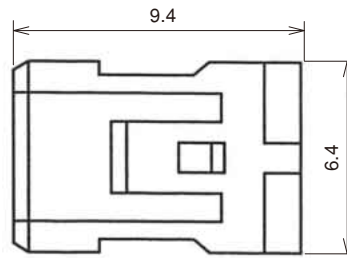

Part No.	HRS No.	Material	Color	Packaging	RoHS
GT19S-1S-R	769-0018-4	PBT	Dark Gray	1	YES

May.1.2016 Copyright 2016 HIROSE ELECTRIC CO., LTD. All Rights Reserved.

- GT5
- GT13
- GT16
- PO5G
- GT19
- GT21
- GT26
- GT36
- GT11
- GT17
- GT32
- GT3
- GT7
- GT10
- GT18W
- GT25
- GT8E
- GT9
- GT15

M Connectors



◆ Mated condition

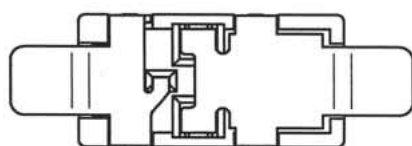
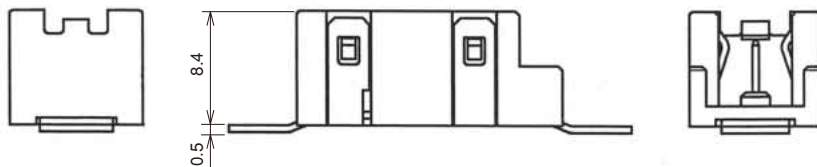
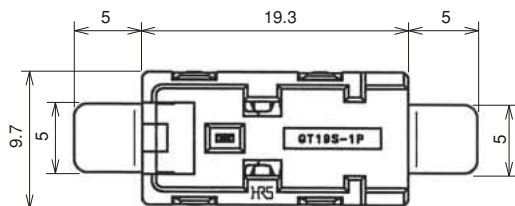
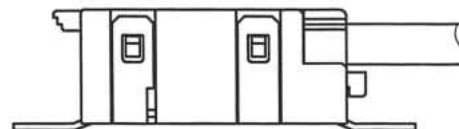
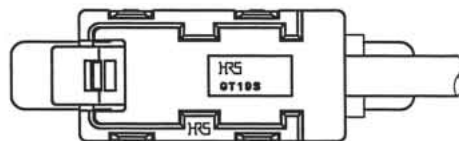

Part No.	HRS No.	Material/Plating or Color	Packaging	RoHS
GT19S-1P-V	769-0019-7	Housing : PPS/Black Center terminal : Brass/Tin plating Outer terminal : Copper alloy/Tin plating	1	YES

◆ Crimping tools

User's manuals are available. Please ask your Hirose Electric account representative.

● Automatic Crimping Machine

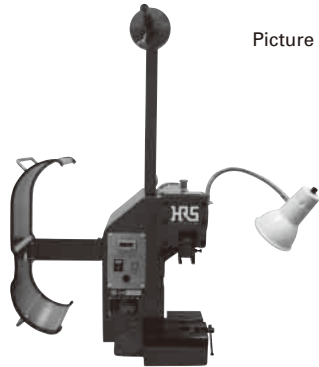

Picture reference only

Part No. CM-105C

Specifications

Item	Specification	Remarks
Press capacity	1.5ton	
Stroke	30mm	
Number of strokes	200spm (50Hz)	240spm (60Hz)
Weight	72kg	
Motor	0.2kW	AC100V
Crimping speed	2,000~4,000 pieces/H	

Applicators

Terminal Product No.	Terminal HRS No.	Tool No.	Tool HRS No.
GT19N-2022/F3.3-5SCF(70)	769-0001-1 70	AP105-GT19N-2022/F33-5SID	901-5090-0
GT19S-30SCF	769-0014-3	AP105-GT19S-30S	901-5150-0
		AP105-GT19S-30S-ID	901-5167-3
GT19S-2428SCF	769-0021-9	AP105-GT19S-2428S	901-5178-0
GT19S-/1.6-2.9SC	769-0016-9	GT19S-1.6-2.9S/CK-MP	902-5516-7
		GT19S-1.6-2.9S/CK-MP3	902-5518-2

Note 1 : Crimp heights are different for each style of cable. When using cables other than those recommended, please consult with Hirose.

When using cables other than those specified, Hirose will need to establish the correct crimp heights.

Note 2 : Before purchasing genuine Hirose tooling, please inquire if your intended cable has been approved for use on the Hirose tooling.

Note 3 : When using cables other than those recommended, modifications to the tooling may be needed. Please consult with Hirose.

For Antenna

- GT5
- GT13
- GT16
- PO5G
- GT19
- GT21
- GT26
- GT36
- GT11
- GT17
- GT32
- GT3
- GT7
- GT10
- GT18W
- GT25
- GT8E
- GT9
- GT15