

For Network, High speed communication

GT32 Series

— Shielded connector for high speed transmission / USB3.0, HDMI1.4 —

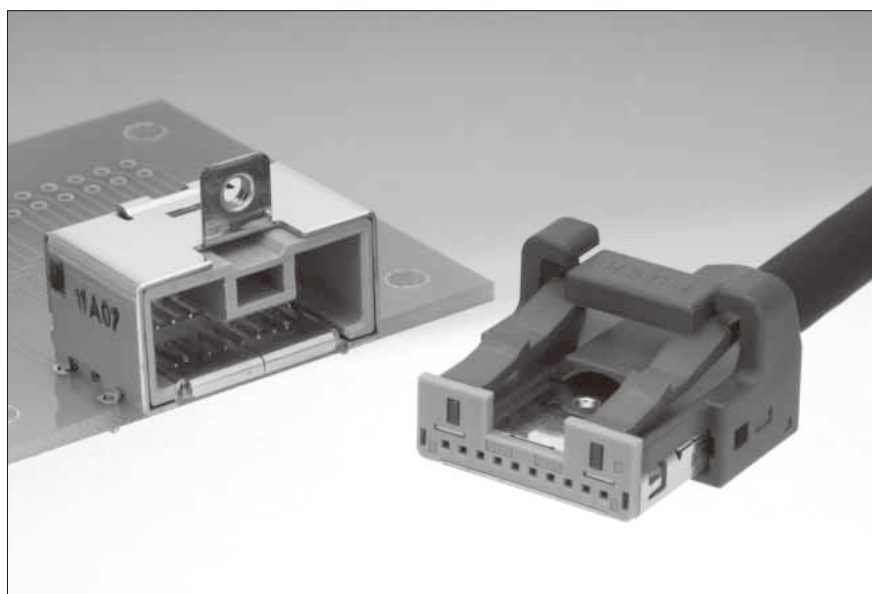

■ Features

- Full shielded structure
- Suitable for in-vehicle shielded connectors

■ Applications

In-vehicle data communication, etc.
 (10-pos : USB3.0 support)
 (19-pos : HDMI1.4 equivalent signal support)

May.1.2016 Copyright 2016 HIROSE ELECTRIC CO., LTD. All Rights Reserved.

GT5

GT13

GT16

PO5G

GT19

GT21

GT26

GT36

GT11

GT17

GT32

GT3

GT7

GT10

GT18W

GT25

GT8E

GT9

GT15

For Network, High speed communication

GT5
GT13
GT16
PO5G
GT19
GT21
GT26
GT36
GT11
GT17
GT32
GT3
GT7
GT10
GT18W
GT25
GT8E
GT9
GT15

F connector

Center terminal

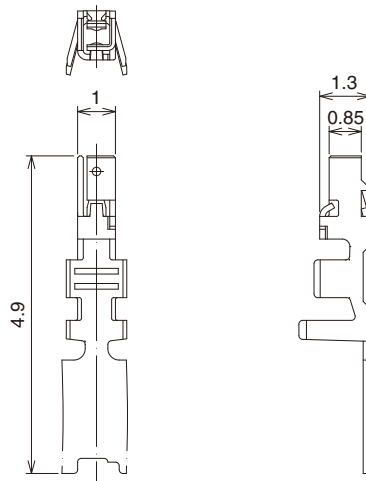
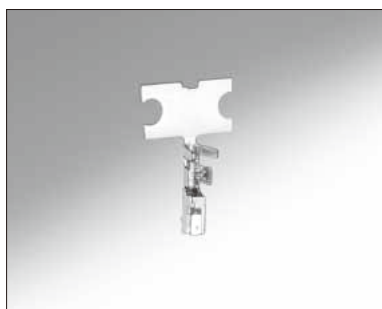

| Part No. | HRS No. | Material | Plating | Conductor Size (AWG) | Outer Diameter | Packaging | RoHS |
|--------------|------------|--------------|-------------|----------------------|----------------|-----------------|------|
| GT32-2428SCF | 782-0007-8 | Copper alloy | Tin plating | 24 to 28 AWG | φ 0.8 to 1.0 | 10,000 pcs/reel | YES |

10-pos straight plug connector

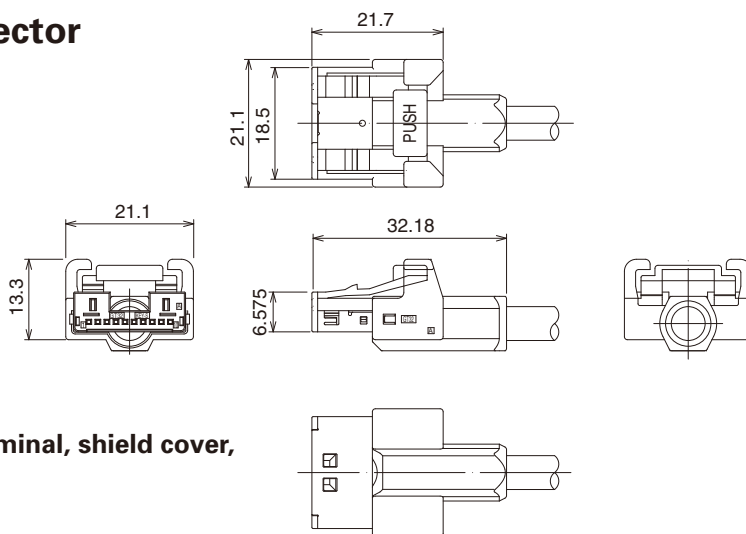
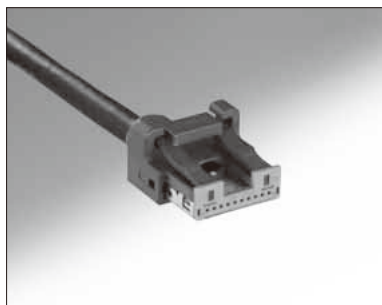

◆ This product consists of six parts.
(Housing, S insulation case, outer terminal, shield cover, shield plate, center terminal)

Housing

| Part No. | HRS No. | Material | Color | Packaging | RoHS |
|-------------|------------|----------|-----------|-----------|------|
| GT32-10S-HU | 782-0003-7 | PBT | Dark Gray | 1 | YES |

S insulation case

| Part No. | HRS No. | Material | Color | Packaging | RoHS |
|---------------|------------|----------|------------|-----------|------|
| GT32-10S-1.5C | 782-0002-4 | PBT | Light Gray | 1 | YES |

Outer terminal

| Part No. | HRS No. | Material | Plating | Outer Diameter | Packaging | RoHS |
|--------------|------------|--------------|-------------|----------------|-----------|------|
| GT32-10S-6CF | 782-0004-0 | Copper alloy | Tin plating | φ 5.4 to 5.8 | 1 | YES |

Shield cover

| Part No. | HRS No. | Material | Plating | Packaging | RoHS |
|-------------|------------|----------|-------------|-----------|------|
| GT32-10S-SC | 782-0005-2 | Brass | Tin plating | 1 | YES |

Shield plate

| Part No. | HRS No. | Material | Plating | Packaging | RoHS |
|-------------|------------|----------|-------------|-----------|------|
| GT32-10S-SP | 782-0006-5 | Brass | Tin plating | 1 | YES |

Center terminal

| Part No. | HRS No. | Material | Plating | Conductor Size (AWG) | Outer Diameter | Packaging | RoHS |
|--------------|------------|--------------|-------------|----------------------|----------------|-----------------|------|
| GT32-2428SCF | 782-0007-8 | Copper alloy | Tin plating | 24 to 28 AWG | φ 0.8 to 1.0 | 10,000 pcs/reel | YES |

◆ Mating table

| Color | Cable connector | Board connector |
|------------|-----------------|-----------------|
| Light Gray | GT32-10S-ASSY | GT32-10P-1.5H |

■ 10-pos board connector (right-angle SMT type)

● M2.5 screw flange type

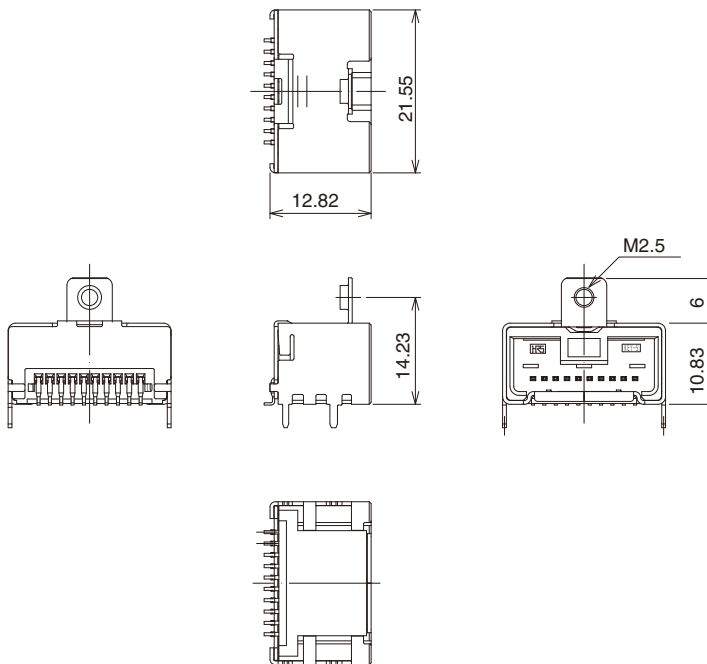
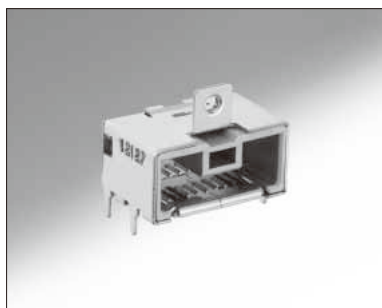

| Part No. | HRS No. | Color | Material/Plating | Packaging | RoHS |
|---------------|------------|------------|---|-----------|------|
| GT32-10P-1.5H | 782-0001-1 | Light Gray | Housing : PPS Center terminal : Brass/Tin plating Outer terminal : Copper alloy/Tin plating | 1 | YES |

May.1.2016 Copyright 2016 HIROSE ELECTRIC CO., LTD. All Rights Reserved.

For Network, High speed communication

- GT5
- GT13
- GT16
- PO5G
- GT19
- GT21
- GT26
- GT36
- GT11
- GT17
- GT32**
- GT3
- GT7
- GT10
- GT18W
- GT25
- GT8E
- GT9
- GT15

GT5
GT13
GT16
PO5G
GT19
GT21
GT26
GT36
GT11
GT17
GT32
GT3
GT7
GT10
GT18W
GT25
GT8E
GT9
GT15

19-pos straight connector

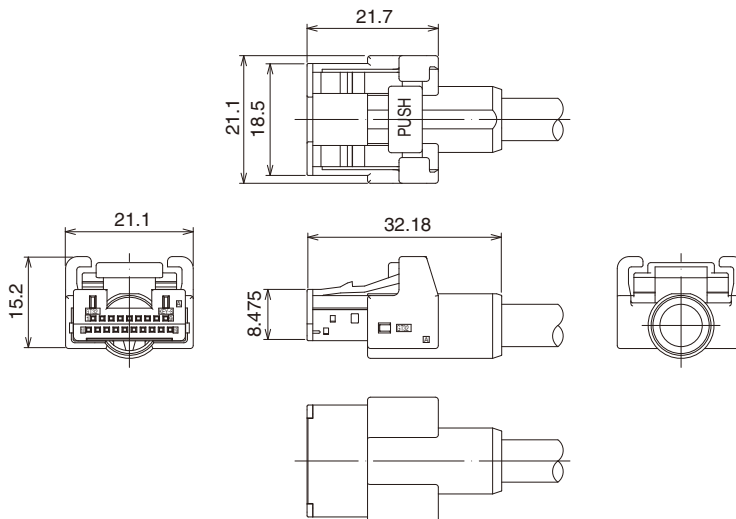
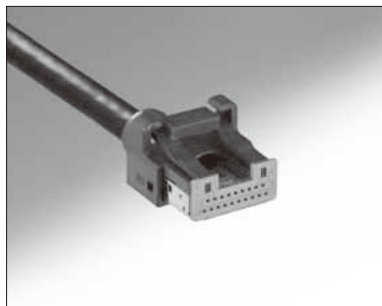

◆ This product consists of six parts.
(Housing, S insulation case A, S insulation case B, outer terminal, shield cover, center terminal)

● Housing

| Part No. | HRS No. | Material | Color | Packaging | RoHS |
|--------------|------------|----------|-----------|-----------|------|
| GT32-19DS-HU | 782-0013-0 | PBT | Dark Gray | 1 | YES |

● S insulation case A

| Part No. | HRS No. | Material | Color | Packaging | RoHS |
|------------------|------------|----------|------------|-----------|------|
| GT32-19DS-0.75CA | 782-0010-2 | PBT | Light Gray | 1 | YES |

● S insulation case B

| Part No. | HRS No. | Material | Color | Packaging | RoHS |
|------------------|------------|----------|------------|-----------|------|
| GT32-19DS-0.75CB | 782-0014-3 | PBT | Light Gray | 1 | YES |

● Outer terminal

| Part No. | HRS No. | Material | Plating | Outer Diameter | Packaging | RoHS |
|---------------|------------|--------------|-------------|----------------|-----------|------|
| GT32-19DS-7CF | 782-0011-5 | Copper alloy | Tin plating | φ 6.8 to 7.2 | 1 | YES |

● Shield cover

| Part No. | HRS No. | Material | Plating | Packaging | RoHS |
|--------------|------------|----------|-------------|-----------|------|
| GT32-19DS-SC | 782-0012-8 | Brass | Tin plating | 1 | YES |

● Center terminal

| Part No. | HRS No. | Material | Plating | Conductor Size (AWG) | Outer Diameter | Packaging | RoHS |
|--------------|------------|--------------|-------------|----------------------|----------------|-----------------|------|
| GT32-2428SCF | 782-0007-8 | Copper alloy | Tin plating | 24 to 28 AWG | φ 0.8 to 1.0 | 10,000 pcs/reel | YES |

◆ Mating table

| Color | Cable connector | Board connector | |
|------------|-----------------|------------------|-------------------|
| | | Right-angle type | DIP type |
| Light Gray | GT32-19DS-ASSY | GT32-19DP-0.75H | GT32-19DP-0.75DSA |

19-pos board connector (right-angle SMT type)

● M2.5 screw flange type

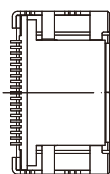
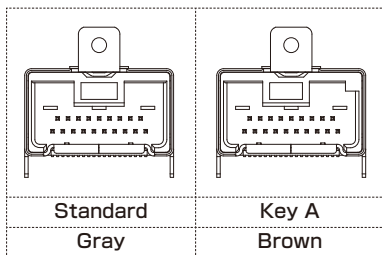
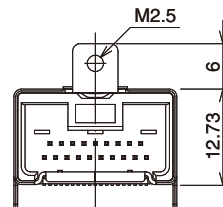
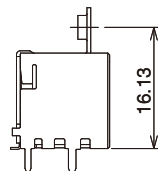
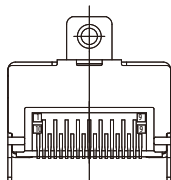
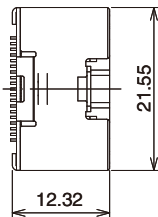

| Part No. | HRS No. | Color | Material/Plating | Packaging | RoHS |
|--------------------|------------|-------|--|-----------|------|
| GT32-19DP-0.75H | 782-0009-3 | Gray | Housing : PA Center terminal : Brass/Tin plating Outer terminal : Copper alloy/Tin plating | 1 | YES |
| GT32-19DP-0.75H(A) | 782-0015-6 | Brown | | | |

19-pos board connector (straight DIP type)

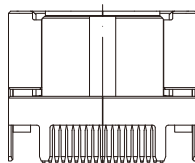
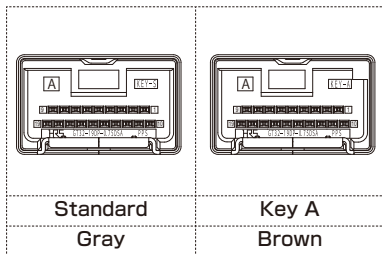
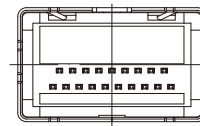
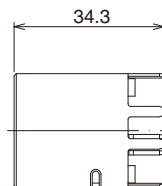
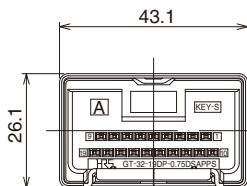
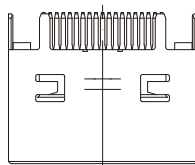

| Part No. | HRS No. | Color | Material/Plating | Packaging | RoHS |
|-----------------------|------------|-------|---|-----------|------|
| GT32-19DP-0.75DSA | 782-0037-9 | Gray | Housing : PPS Center terminal : Brass/Tin plating Outer terminal : Copper alloy/Tin plating | 1 | YES |
| GT32-19DP-0.75DSA (A) | 782-0045-7 | Brown | | | |

GT5

GT13

GT16

PO5G

GT19

GT21

GT26

GT36

GT11

GT17

GT32

GT3

GT7

GT10

GT18W

GT25

GT8E

GT9

GT15

For Network, High speed communication

◆ Crimping tools

Operation manuals are available for each crimp tool. Please contact sales personnel.

● Automatic Crimping Machine

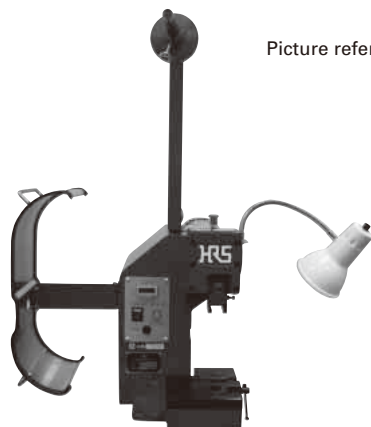

Picture reference only

Specifications

| Item | Specification | Remarks |
|-------------------|-----------------------|---------------|
| Press capacity | 1.5Ton | |
| Stroke length | 30mm | |
| Number of strokes | 200spm (50Hz) | 240spm (60Hz) |
| Weight | 75kg | |
| Motor | 0.2kW | AC100V |
| Crimping speed | 2000 to 4000 pcs/hour | |

Part No. CM-105C

Note : Please refer to the table below for applicator product numbers.

Applicator (for use with the automatic crimping machine)

| Terminal Product No. | Terminal HRS No. | Tool Product No. | Tool HRS No. |
|----------------------|------------------|------------------|---------------|
| GT32-2428SCF | 782-0007-8 | AP105-GT32-2428S | 901-5223-2 00 |

Note 1 : The crimp height is to be set for each cable type. Please request your contact person for details.

Note 2 : The P/N for applicator/tool may differ from the above P/N depending on the cable specification.

Special terminal insertion tool for GT32-10S-1.5C

| Terminal Product No. | Terminal HRS No. | Tool No. | Tool HRS No. |
|----------------------|------------------|----------------|--------------|
| GT32-2428SCF | 782-0007-8 | GT32-CON/PR-MD | 902-5125-0 |

* This product is used only to insert GT32-2428SCF terminal into S insulation case GT32-10S-1.5C.

Please note that this product cannot be used for other terminals and insulation cases.

● Hand press

Hand press



Product No. HOS-7

Outer terminal applicator (for hand press mounting)

| Product Part No. | Product HRS No. | Tool Part No. | Tool HRS No. |
|------------------|-----------------|--|--------------------------------|
| GT32-10S-6CF | 782-0004-0 | GT32-10S-6/CR-MP GT32-10S-6/CR-MP(01) | 902-5118-4 00 902-5118-4 01 |
| GT32-19DS-7CF | 782-0011-5 | GT32-19DS-7/CR-MP GT32-19DS-7/CR-MP(01) | 902-5124-7 00 902-5124-7 01 |

Note 1 : (01) version is to be supplied with the hand press "HOS-7".

Note 2 : The crimp height is to be set for each cable type. Please request your contact person for details.

Note 3 : The P/N for applicator/tool may differ from the above P/N depending on the cable specification.