

NOTE:

1. MATERIAL AND FINISH

1.1. SHELL ASSEMBLY: COPPER ALLOY, OUTER SHELL AND COLLET NUT Cr PLATING, OTHER METALLIC COMPONENTS Ni PLATING

1.2. INSULATOR: PEEK

1.3. CONTACT: COPPER ALLOY, GOLD PLATING

2. RoHS COMPLIANCE

③ CRIMP CONTACT DETAILS SHOWN IN VIEW 1

4. PART NO.

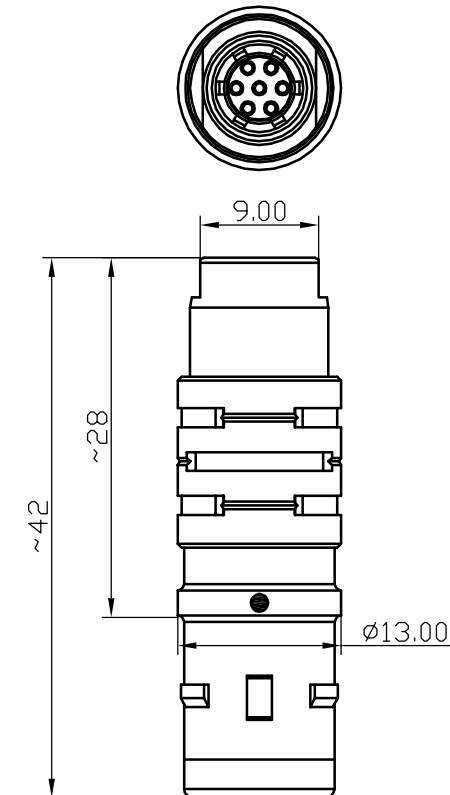
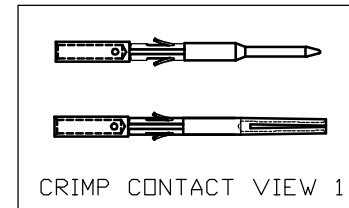

R - F 1 K S \* \* 0 \* C 2 \* \* \*

CONTACT POS.	02-16=2pin-16pin
--------------	------------------

SHELL MATERIAL	0=Brass
----------------	---------

CODE	CONTACT TYPE
2	Male Solder Contact
4	Female Solder Contact
③ C	Crimp Male Contact
③ M	Crimp Female Contact
1	Male Print Contact
3	Female Print Contact

COLLET NUT	2=Nut for Standard
------------	--------------------

CABLE OD	
15=OD:1.3mm-1.5mm	55=OD:5.1mm-5.5mm
20=OD:1.6mm-2.0mm	60=OD:5.6mm-6.0mm
25=OD:2.1mm-2.5mm	65=OD:6.1mm-6.5mm
30=OD:2.6mm-3.0mm	
35=OD:3.1mm-3.5mm	
40=OD:3.6mm-4.0mm	
45=OD:4.1mm-4.5mm	
50=OD:4.6mm-5.0mm	

CODE	KEY ANGLES
0	0
A	30°
B	60°
..	..

UNITS		
mm	INCH	
GENERAL TOLERANCES: (UNLESS SPECIFIED)		
	mm	INCH
4 PLACE	± **	± .**
3 PLACE	± 0.10	± .**
2 PLACE	± 0.30	± .**
1 PLACE	± 0.50	± .**
ANGULAR:	X° ± 2°	X° ± **

NAME:	SNAP LATCH METAL 1K STRAIGHT PLUG
PART NO:	R-F1KS**0*C2***
APPD:	Seawen 4/8/14
CHKD:	Annie 4/8/14
DRAWN:	Alex 4/8/14

 NEXTRONICS ENGINEERING CORP.	
TITLE: CUSTOMER DWG.	
DWG NO:	010-0000-B34
SCALE:	2.5/1
SHEET:	2/3
REV.:	X1

X1	NEW RELEASE	4/8'14	Seawen
REV.	DESCRIPTION	DATE	APPD

KEY ANGLES (RECEPTACLE FRONT VIEW):

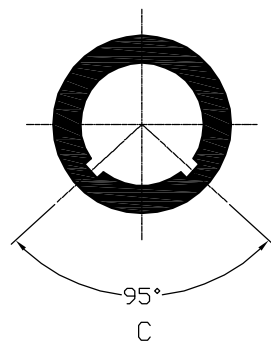
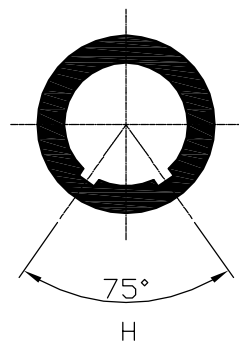
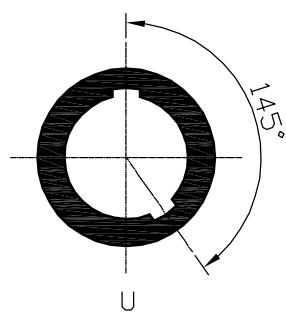
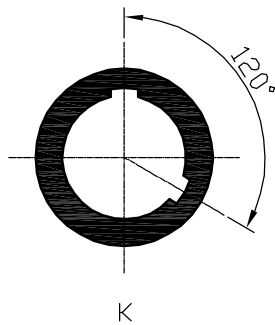
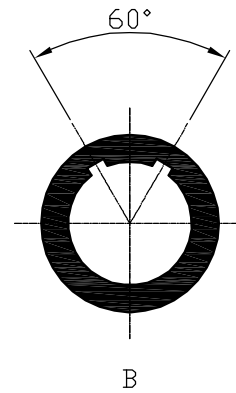
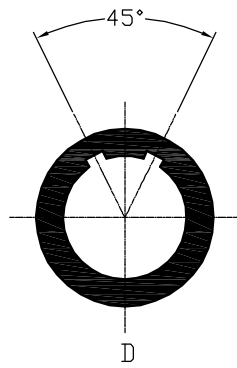
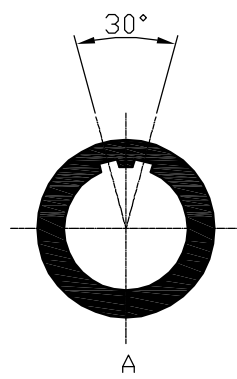
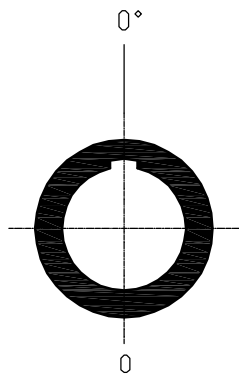

UNITS	
<input checked="" type="checkbox"/> mm	<input type="checkbox"/> INCH
GENERAL TOLERANCES: (UNLESS SPECIFIED)	
	mm INCH
4 PLACE	± **. ± **.
3 PLACE	± 0.10 ± **.
2 PLACE	± 0.30 ± **.
1 PLACE	± 0.50 ± **.
ANGULAR:	X° ± 2° X° ± **.

NAME:	SNAP LATCH METAL
	1K STRAIGHT PLUG
PART NO:	R-F1KS**0*****
APPD:	Seawen 4/8/14
CHKD:	Annie 4/8/14
DRAWN:	Alex 4/8/14

<b>nexttron</b> <sup>®</sup>		
NEXTRONICS ENGINEERING CORP.		
TITLE:		
CUSTOMER DWG.		
DWG NO:	010-0000-B34	C
SCALE:	SHEET:	REV.:
2.5/1	3/3	X1

X1	NEW RELEASE	4/8'14	Seawen
REV.	DESCRIPTION	DATE	APPD